

AQtivate 200

Configuration tool

Instruction manual

Table of contents

1 Document information	3
1.1 Version 2 revision notes	3
1.2 Version 1 revision notes	3
2 Introduction	5
3 Getting started	6
3.1 Installing the AQtivate setting tool	6
3.2 Updating the AQtivate setting tool	6
3.3 Connecting to relay with AQtivate	7
3.3.1 Relay IP addresses	7
3.3.2 Setting the Ethernet ports IP address for communication through the back port	8
3.3.3 Connecting through the back port	9
3.3.4 Device list	9
3.3.5 Connecting by launching AQtivate through command line	10
3.4 Settings menu	10
3.4.1 General	11
3.4.2 Appearance	12
3.4.3 Shortcuts	16
4 Managing .aqz files	18
4.1 Reading .aqz setting files from the device	18
4.2 Opening and saving .aqz files	19
4.3 Uploading configurations	19
4.3.1 Write to relay	19
4.3.2 Write changes	20
4.3.3 Live Edit	21
4.3.4 Reconfiguring communication settings	22
5 Online Edit menus	23
5.1 Introduction and navigation	23
5.2 General menu	26
5.3 Protection menu	28
5.4 Control menu	34
5.4.1 Controls enabled	34
5.4.2 Setting groups	34
5.4.3 Objects	36
5.4.4 Control functions	37
5.4.5 Device I/O tab	37
5.5 Communication menu	39
5.5.1 Connections	39
5.5.2 Protocols	39
5.5.3 General I/O	41
5.5.4 Real-time signals to communication	41
5.6 Measurement menu	41
5.7 Monitoring menu	43
6 Commands menu	49
6.1 Time settings	49
6.2 Uploading language files	50
6.3 Set timers	51
6.4 User levels and their passwords	51
6.5 Clearing Event buffer	54
6.6 Reconfiguring communication settings	54
6.7 Safe Settings mode	54
7 Tools menu	56
7.1 Running scripts	56
7.2 Mimic editor (AQ-210 series)	56
7.3 Mimic editor (AQ-250 series)	59
7.4 Logic editor	66

7.4.1 Logic editor (AQ-210 series)	66
7.4.2 Logic editor (AQ-250 series)	69
7.4.3 Logic gates.....	74
7.5 Carousel Designer (AQ-210 series)	81
7.6 Carousel Designer (AQ-250 series)	82
7.7 Project editor	83
7.8 Wizard	83
7.9 Events and logs	85
7.9.1 Event history.....	85
7.9.2 Event list.....	87
7.9.3 Configuration change log.....	87
7.9.4 Set alarm events.....	88
7.10 Communication	88
7.10.1 IEC 61850.....	88
7.10.2 Modbus map	98
7.10.3 Modbus configurator	99
7.10.4 SPA map	108
7.10.5 DNP	109
7.10.6 IEC 103.....	109
7.10.7 IEC 101/104.....	110
7.10.8 Modbus Gateway	110
7.11 Miscellaneous tools	118
7.11.1 Find signal usage.....	118
7.11.2 Measurement recorder	119
7.11.3 Aqs generator	120
7.11.4 Compare files	120
7.11.5 Copy SG settings	121
7.11.6 Calibrations	121
7.11.7 Clear matrix.....	122
7.11.8 Rear panel.....	122
7.11.9 DI configurator	122
7.11.10 GC-30 configurator	123
7.12 FTP	124
7.13 Device list	125
8 Exporting and importing settings in a .txt file.....	126
9 Print menu.....	128
10 Updating firmware.....	129
11 Viewing disturbance recordings with AQviewer	132
12 Adding an option card	134
13 Contact and reference information.....	135

1 Document information

1.1 Version 2 revision notes

Revision	2.00
Date	7.6.2019
Changes	- Updated look and presentation of the manual.
Revision	2.01
Date	21.10.2019
Changes	<ul style="list-style-type: none"> - Content completely rewritten to improve grammar and readability. - Improved images. - Updated AQ-210 series logic editor descriptions and images to match with new logic editor. - Added relay communication menu descriptions. - Added descriptions for miscellaneous tools: Calibrations, clear matrix, DI configurator, GC-30 configurator.
Revision	2.02
Date	3.6.2021
Changes	<ul style="list-style-type: none"> - Grammar and readability improved further. - Added measurement bar description to mimic editor manual. - Improved images. - Added more descriptions to many topics. - Added Modbus Gateway tool description. - Replaced old IEC61850 editor description with new IEC61850 editor description.

1.2 Version 1 revision notes

Revision	1.00
Date	12.10.2012
Changes	- N/A
Revision	1.01
Date	25.2.2013
Changes	- FTP added, time settings added, tools menu edited, print-menu updated, firmware upgrade added, safe setting mode added.
Revision	1.02
Date	16.5.2013
Changes	- Front panel connection added, connecting the device edited, event history edited, alarm events added, compare aqs-files added.
Revision	1.03
Date	11.9.2014
Changes	<ul style="list-style-type: none"> - Descriptions added: AQS-generator, Signal swap, Find signal usage, Project editor, Carousel designer, Timers, IEC61850 setting, Uploading language files, User levels, Firmware upgrade, AQviewer. - Descriptions updated: Mimic editor, Logic editor, Settings, Disturbance recorder.
Revision	1.04
Date	20.2.2015
Changes	- Added instructions for adding an option card.
Revision	1.05
Date	24.4.2015

Changes	<ul style="list-style-type: none"> - Added SPA and DNP protocol tools. - Added Configuration changelog.
Revision	1.06
Date	12.8.2015
Changes	<ul style="list-style-type: none"> - Revised: Tools menu, Commands menu, Logic editor, Mimic editor. - Added: Write to relay, Trafo Wizard, Update manager.
Revision	1.07
Date	09.11.2015
Changes	<ul style="list-style-type: none"> - Improved and added images to many chapters. - The order of chapters improved. - Overall revising of the look and readability of the manual. - Added hyperlinks to various download pages to relevant chapters.
Revision	1.08
Date	6.9.2016
Changes	<ul style="list-style-type: none"> - Further improvement on readability, images revised and hyperlinks to other documents added.
Revision	1.09
Date	12.1.2018
Changes	<ul style="list-style-type: none"> - Added AQ250 series mimic, logic and carousel designer descriptions. - Hyperlinks fixed to fit the new Arcteq web page.
Revision	1.10
Date	24.5.2018
Changes	<ul style="list-style-type: none"> - AQ-250 logic editor description revised.
Revision	1.11
Date	20.8.2018
Changes	<ul style="list-style-type: none"> - AQ-250 mimic editor description revised.
Revision	1.12
Date	10.9.2018
Changes	<ul style="list-style-type: none"> - AQ-250 logic editor description additions.
Revision	1.13
Date	10.12.2018
Changes	<ul style="list-style-type: none"> - Carousel designer for AQ-250 series units. - DI-configurator description added. - GC-30 configurator description added. - AQ-250 mimic editor description revised. - IEC101/104 & IEC103 map view description added.

2 Introduction

The **AQtivate 200** software tool is a program used for setting and making configurations for Arcteq AQ-200 series protection and control devices. The program uses a modern graphical interface to create a user-friendly configuration. AQtivate can be used for both reading and writing configurations to AQ-200 devices. AQtivate is also capable of reading disturbance recordings from the device. These recordings can be further evaluated by using the AQviewer program (included in the AQtivate 200 software suite).

Relay settings are stored as a single ".aqs" file, which includes all the user settable configurations (protection, measurement, communication, logics, etc.). These .aqs files can be saved and stored on a hard drive. Configuration can be done both online and offline.

AQtivate 200 can be run by any Windows 7/8/10 version. It can be downloaded free of charge from the Arcteq Relays website (<http://arcteq.fi/downloads/>). This requires registration.

3 Getting started

Making a connection to an AQ-200 series device requires a free Ethernet port in your PC and a standard straight connection RJ-45 cable. Please make sure that your firewall and anti-virus protections allow AQtivate to connect and freely use the Ethernet ports of the PC.

3.1 Installing the AQtivate setting tool

First, please launch the "AQtivate Offline Installer". If you do not have the AQtivate installer, you can download it for free from Arcteq's website (<https://www.arcteq.fi/downloads/>).

Then, please select the installer language and follow the step-by-step instructions to install the software.

Some firewall softwares may detect AQtivate 200, which is why you need to either select the option "Allow connection" or manually set AQtivate to the list of allowed programs.

3.2 Updating the AQtivate setting tool

When the installed AQtivate version is too old for the firmware in the relay, it may be necessary to update the setting tool software. You can check the tool's version at *Help* → *Check for updates*. If there is no need to update, a pop-up window appears telling you that "The current version is the newest". However, if an update is needed AQtivate will ask if you want to go to downloads section (see the image below).

Figure. 3.2 - 1. Finding a newer version of AQtivate.

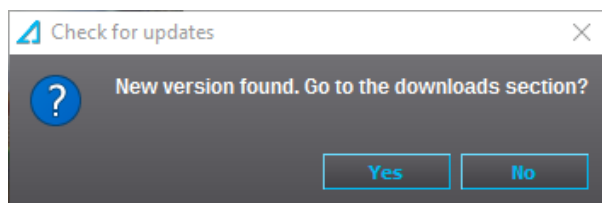

Clicking "Yes" will take you to the Arcteq website where you will be able to download the latest version. Logging in is required to download the software. If you do not have an account, you can create one at [arcteq.fi](https://www.arcteq.fi).

Another common sign indicating that you are running an old AQtivate version is receiving the error message saying that the zip file is not valid (see below). In this case the installed AQtivate version is too old for the configuration file you are attempting to open and a newer version of the setting tool is needed. Check the tool's version and follow the instructions as described above.

Figure. 3.2 - 2. "Zip file is not valid" error message.

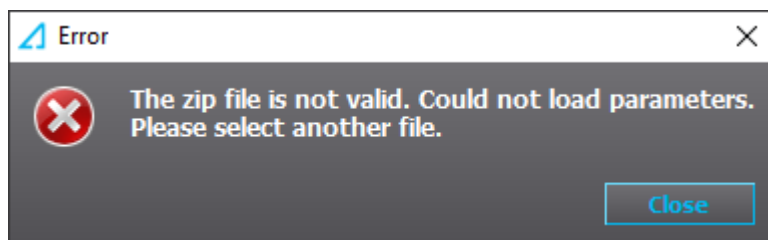

3.3 Connecting to relay with AQtivate

In order to connect to a relay with the AQtivate setting tool, the following ports in the firewall must be open: 20, 21 and 1551. If the connection to the relay fails, please check the settings of your firewall and anti-virus softwares.

3.3.1 Relay IP addresses

AQ-200 series relays are equipped with two RJ-45 ports: one is located in the front panel, the second one in the back. Both can be used to connect the relay with AQtivate.

Figure. 3.3.1 - 3. Ports in AQ-200 devices (front and back).

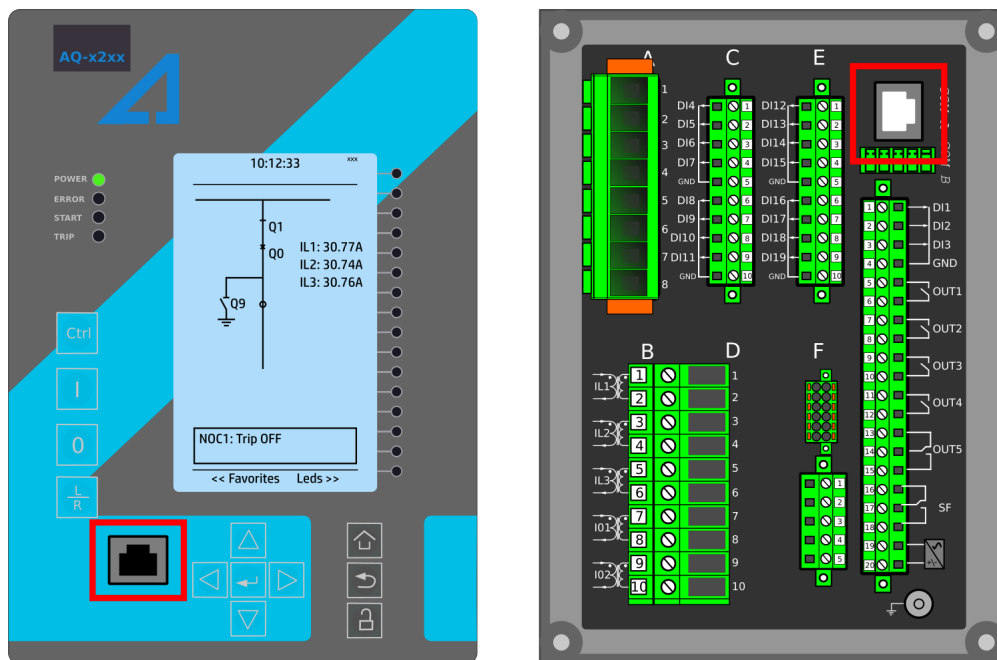

Front port (DHCP server)

The front port of the device has a fixed IP address (192.168.66.9) and an in-built DHCP server capability. This means that a local PC will get the required IP address automatically from the relay. If the PC is unable to automatically connect to the relay through the front port, please change the IP address of the PC ethernet port manually to the same area (192.168.66.x).

To connect to the relay's front port, click on the drop-down menu at the middle of the main tool bar, select "Front Port" and press "Connect".

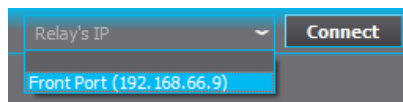

Back port

The IP address of the device's back port is set by the user and can be found by going to *Communication* → *Connections*. The addresses found under this tab define the rear Ethernet communication of the relay. The IP address can also be found in the routine test reports that were sent with the device.

NOTE!



The usability of the two ports differs in two ways: any firmware upgrading is only possible through the back port, and communication protocols only work through the back port. You can find more detailed instructions for firmware upgrading in the chapter titled "Firmware upgrade".

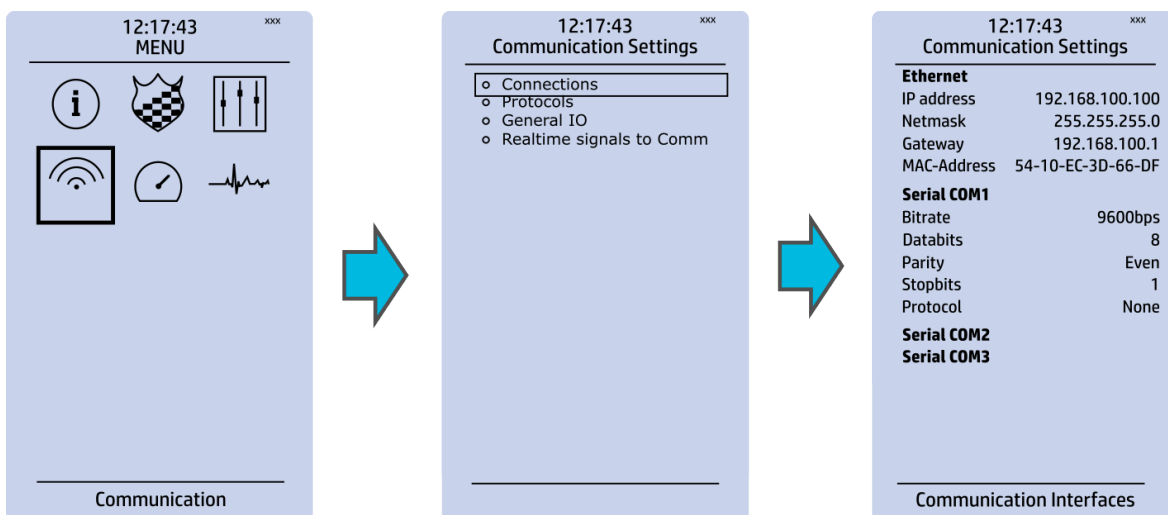

3.3.2 Setting the Ethernet ports IP address for communication through the back port

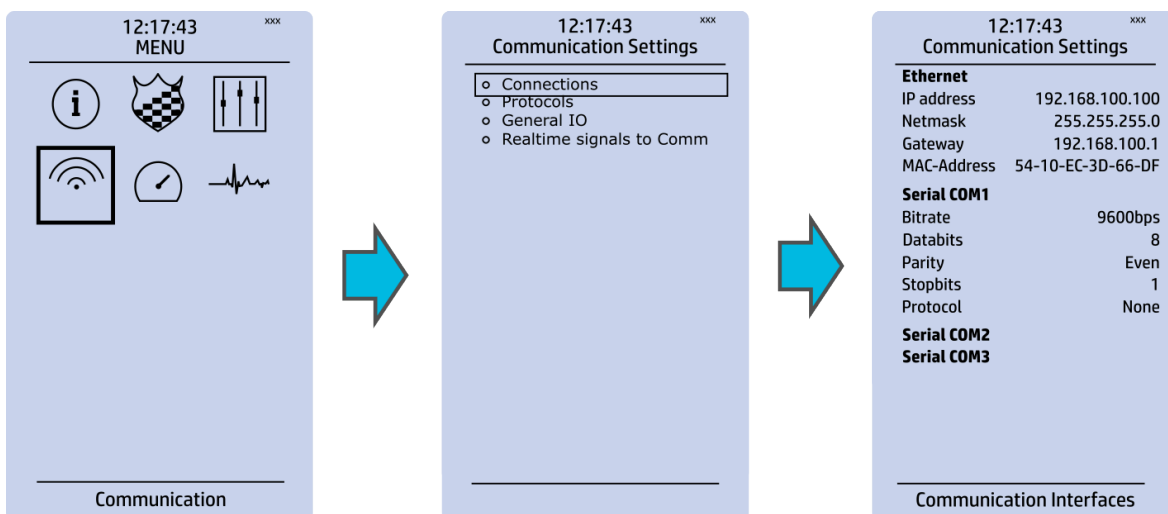

You can set the IP addresses in the relay to match the IP address range of your Ethernet port by going to *Communication* → *Connections*. The addresses found under this menu define the Ethernet communication of the relay.

To check your IP address range, navigate to the network settings of your programming PC. In Microsoft Windows 7 and 10 it can be found through the path pictured below.

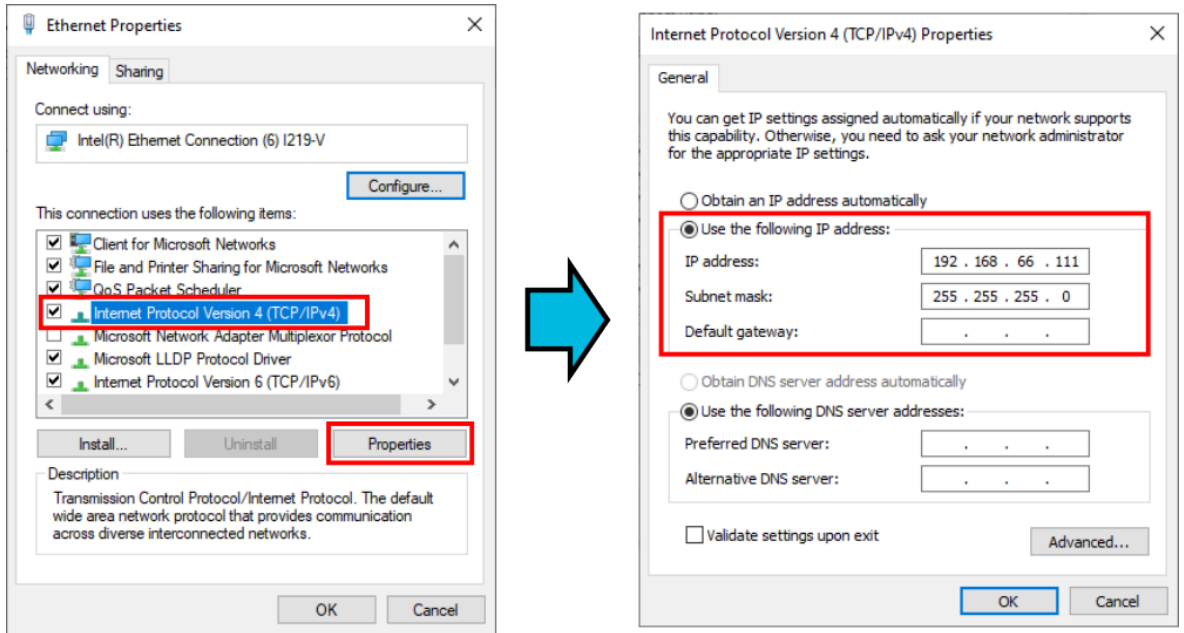

If you have a fixed IP address, it is shown here. If you are connecting through the front port, it is enough to select "Obtain an IP address automatically" in the network settings of your Ethernet port.

3.3.3 Connecting through the back port

Figure. 3.3.3 - 4. Connect box at the top of AQtivate software's main view.



To connect to an AQ-200 series device, type the IP address to the IP address box and then either press the **Enter** key or click "Connect". When you are connected to a relay, the red "Offline" text at the top left corner will turn into a green "Online". When you are connected to a relay through AQtivate, the Arcteq logo will blink on the device to indicate an active connection.

NOTE!



Only one computer can connect to a relay at one time. Attempts to connect to a relay with a second computer won't disrupt the user who connected to the relay first.

NOTE!



Connecting to a relay with AQtivate through the back port does not affect the SCADA connection.

3.3.4 Device list

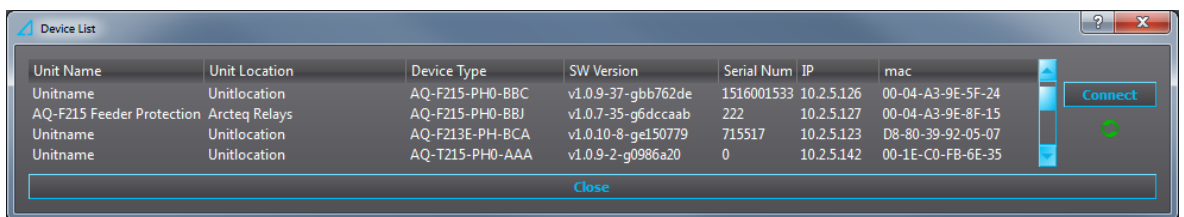

Another way to connect to a device is to open the Device list from the *Tools* menu or by pressing **F11**. The resulting pop-up window shows all the available devices that are connected to the network your computer is in. Double clicking one of the devices in the list, or selecting a device and clicking the "Connect" button will close the window and connect to the selected device. If new devices are connected while the Device list is open, press the green "Refresh" button (below the "Connect" button) to make the new devices appear on the list.



NOTE!

Some switches and firewalls may prevent AQtivate from showing this list.



NOTE!

If you have multiple instances of the AQtivate setting tool running at the same time, the device list will not be able to list the devices in the network.

3.3.5 Connecting by launching AQtivate through command line

AQtivate supports connecting to a device as AQtivate is launched through a command line. Open Command Prompt and simply give the command "AQtivate.exe c- [the device's IP address]". This will launch AQtivate and attempt to connect to the device with the given IP address. For example, if the unit's IP address is 192.168.100.100, you can connect to it when you launch AQtivate in Command Prompt by typing "AQtivate.exe -c 192.168.100.100".

3.4 Settings menu

The *Settings* menu can be found at *Tools* → *Settings*.

Figure. 3.4 - 5. Location of the *Settings* menu

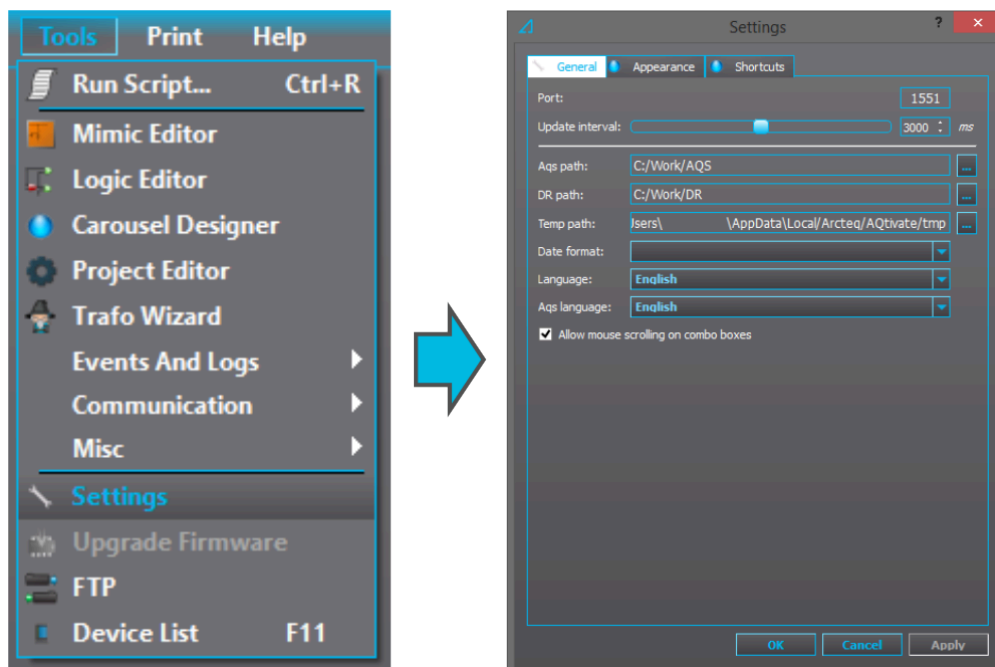

3.4.1 General

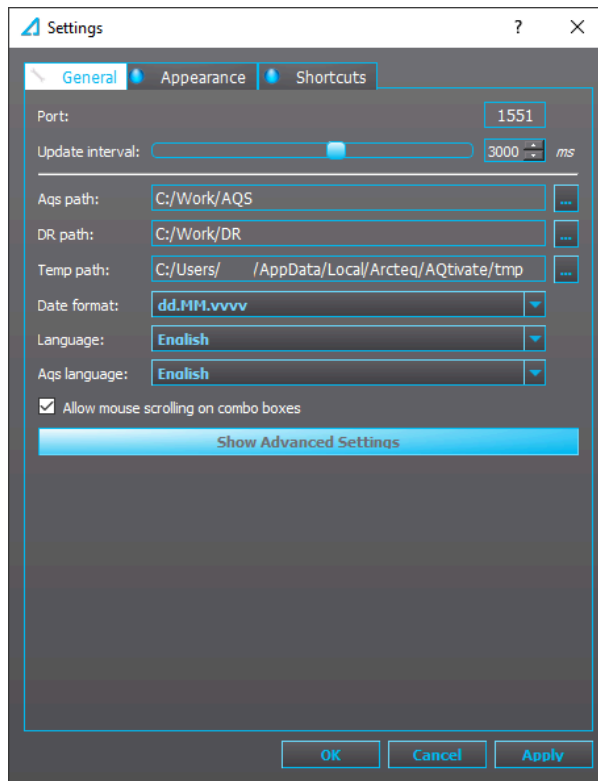

The "Aqs path" defines the location where the configuration files are saved when they are downloaded from the AQ-200 series device with the "Get aqs file" command. The "DR path" defines the location where the disturbance recordings downloaded from the AQ-200 series device are saved when the relay receives the "Get DR files" command. The "Date format" has a drop-down menu of options how to display the date:

- dd.MM.yyyy
- dd/MM/yyyy
- yyyy-MM-dd
- MM/dd/yyyy

Changing the "Language" changes the language of the basic AQtivate menus. Changing the "Aqs language" changes which language is used for the menus generated from the .aqs-file. English is used by default. If "Other" is selected, AQtivate will use the language that was chosen in the "Language" parameter in the *General* menu.

Checking the "Allow mouse scrolling on combo boxes" check box allows the user to change the combo box value by scrolling the mouse wheel when the mouse hovers over the box. In the image below this feature is enabled, and the user can scroll through all the options of the "Timesync. source" parameter. Please note that this feature is disabled by default.

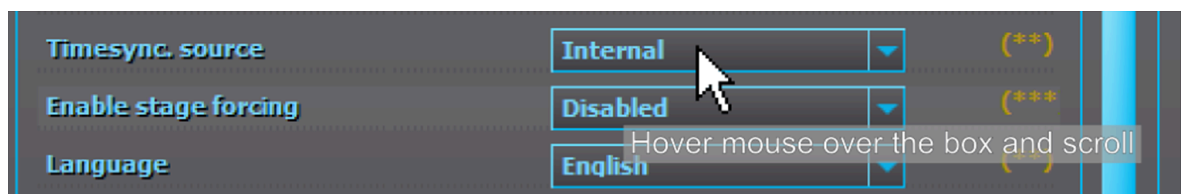

3.4.2 Appearance

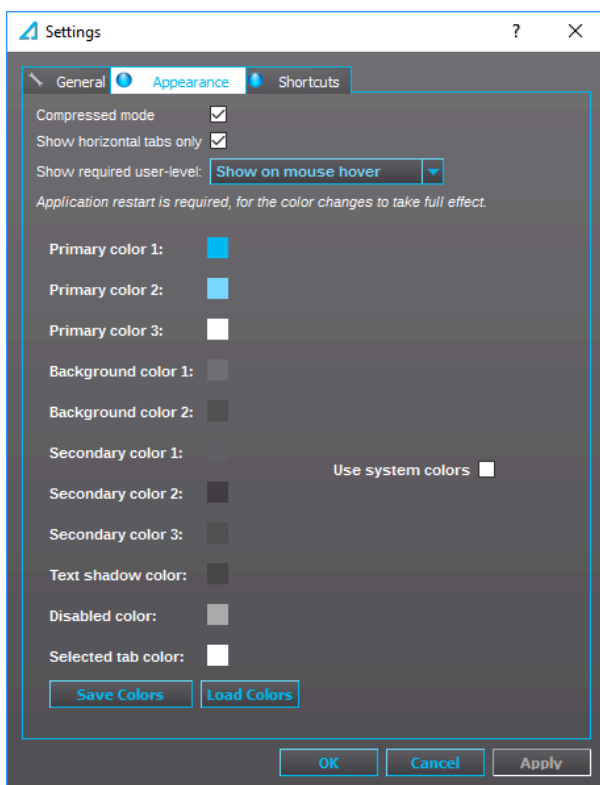

In the *Appearance* tab you can modify the appearance of AQtivate. Some users with low resolution laptops may run into situation where some of the menus do not fit on the window horizontally. You can get more space by activating the *Compressed mode*: this changes the list of submenus into tabs (see the image below).

Figure. 3.4.2 - 6. Normal menu vs. compressed menu.

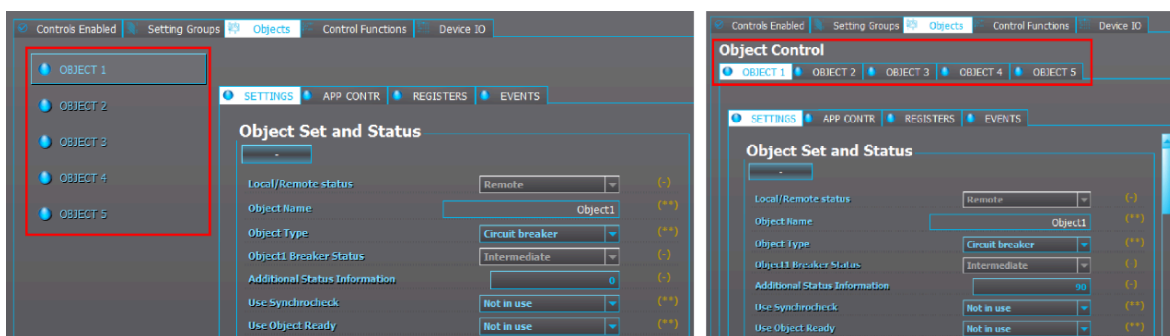

Choosing the *Show horizontal tabs only* mode changes vertical tabs into horizontal (see the image below).

Figure. 3.4.2 - 7. Normal tabs vs. horizontal tabs.

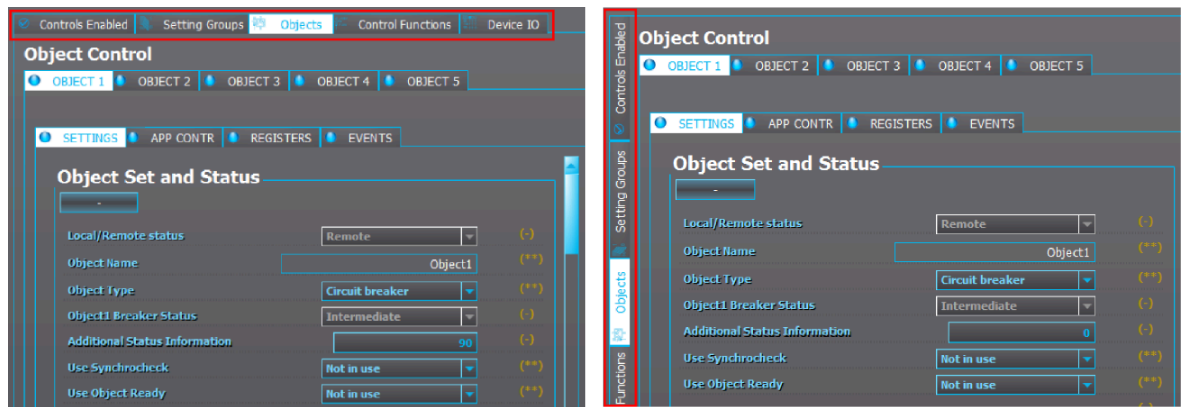

You can also change AQtivate's color scheme. You can select change the various color one by one, or you can select one of the three pre-made color schemes (Arcteq, Arcteq Dark, and Cool Grey). To select one of these, click "Load colors" and select the scheme from the AQtivate 200 install folder (by default the path is C:\Program Files (x86)\Arcteq\AQtivate\color_themes). The images below show what these pre-made color schemes look like.



NOTE!

Changing these settings requires that the .aq5 file is reopened.

Figure. 3.4.2 - 8. The three pre-made color schemes.

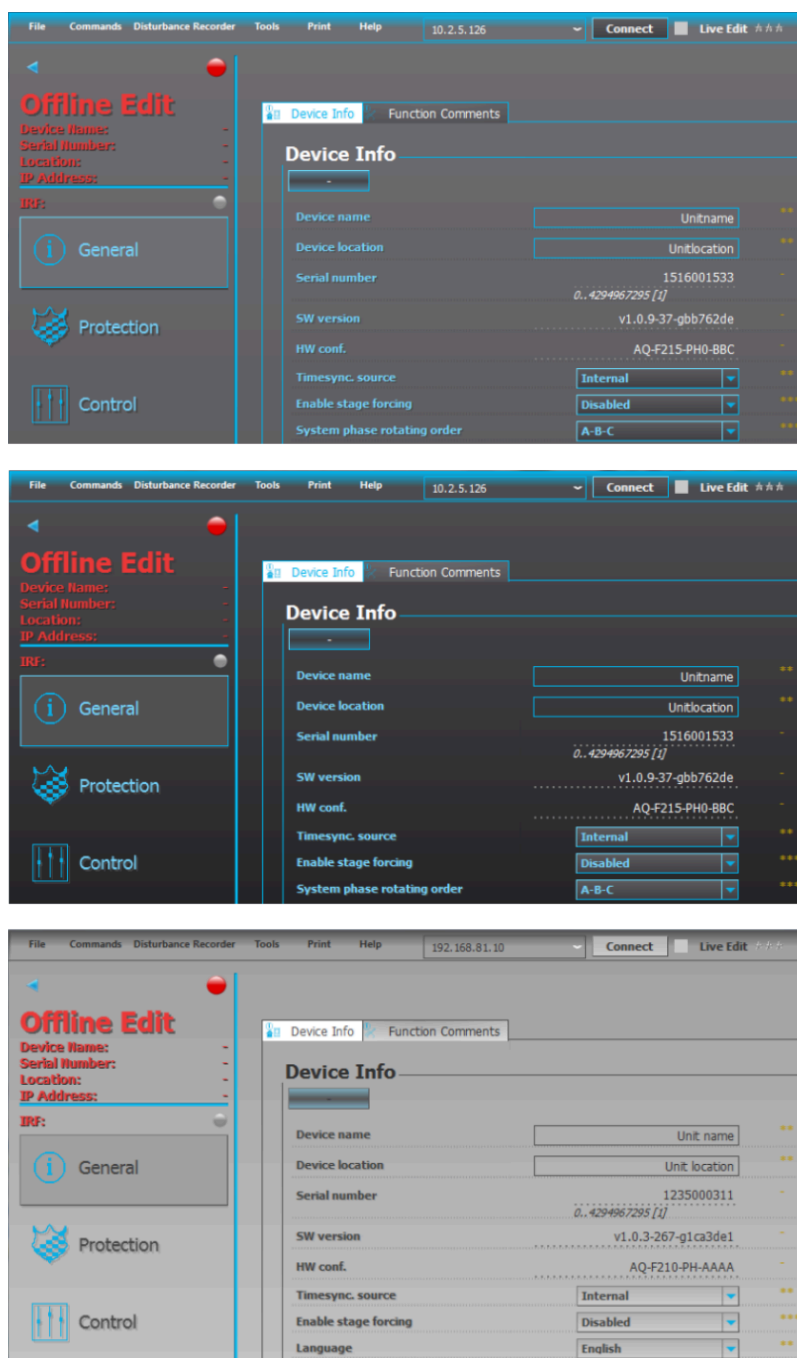

In *Show the required user level* you can change how the required user level is shown by selecting from the three display options: Don't show, Show on mouse hover, and Show.

Figure. 3.4.2 - 9. The three options for showing the required user level.



You can also quickly change between the color scheme of the *Appearance* tab or the Windows colors (see the image below).

Figure. 3.4.2 - 10. "Use system colors" setting ON/OFF.

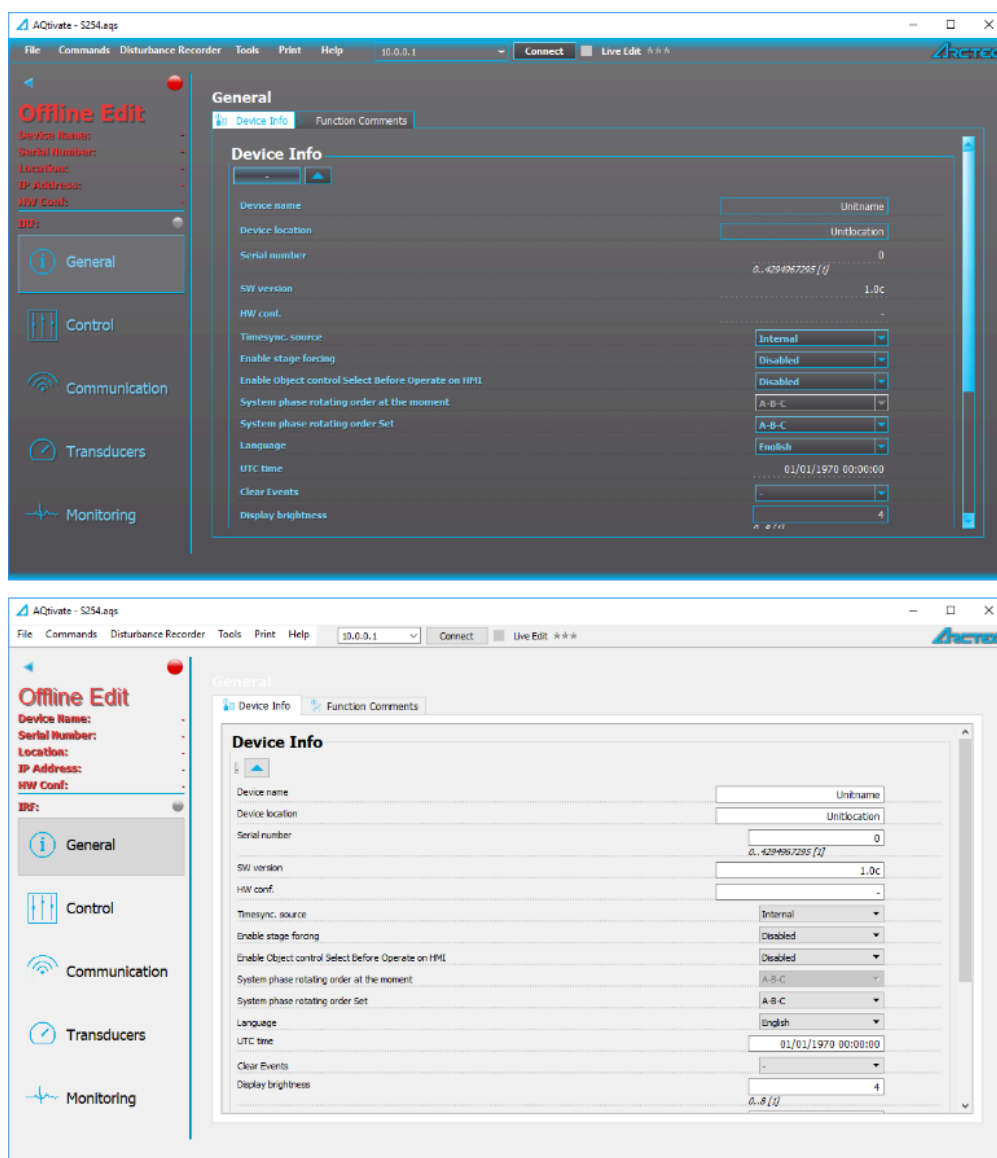

3.4.3 Shortcuts

In the *Shortcuts* tab, you can edit the various menu shortcuts. By default the shortcuts are as shown in the image below.

Figure. 3.4.3 - 11. Shortcuts.

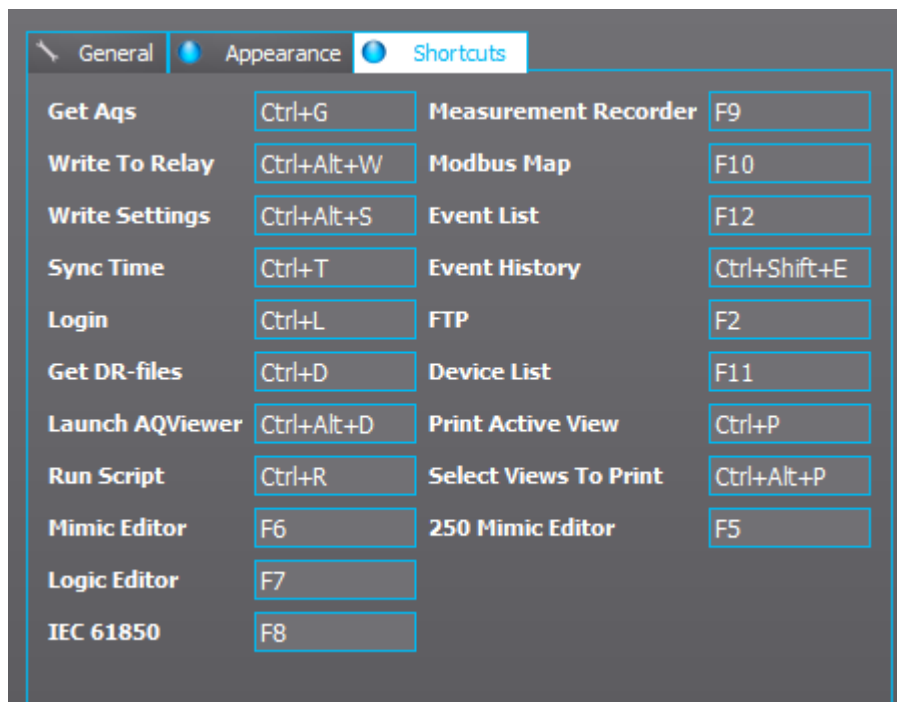

4 Managing .aq5 files

4.1 Reading .aq5 setting files from the device

With AQtivate you can download existing .aq5 files from the relay and they can be stored on the hard drive. To determine where the .aq5 files are saved go to *Tools* → *Settings* and set the *Aqs path* (see the image below). By default, the .aq5 files are saved to AppData/Local/Arc7eq folder.

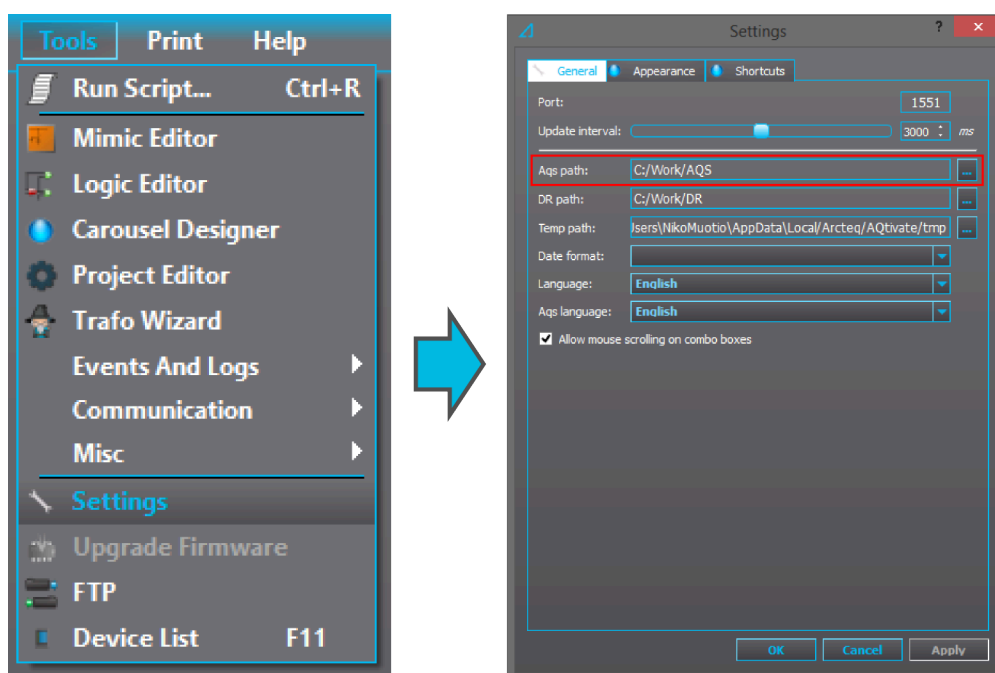

To download a relay's settings to the AQtivate setting tool, connect to the device and go to *Commands* → *Get aqs-file* (or press Ctrl+G). Wait for the program to load the file.

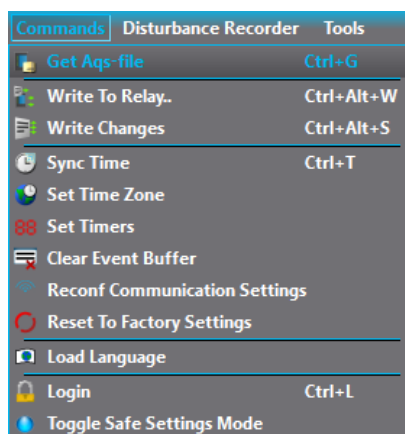

When downloading an .aq5 file from a relay, if an .aq5 file with the same file name already exists in the specified folder, AQtivate asks the user whether the loaded file will overwrite the original (click "OK"), or whether the loaded file will automatically be renamed and the original preserved (click "Cancel").

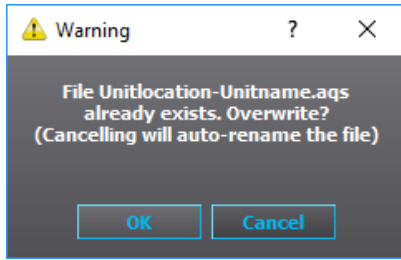

4.2 Opening and saving .aqs files

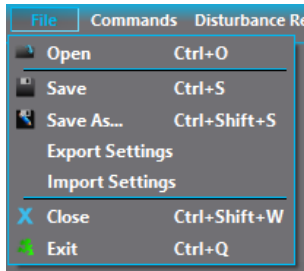

You can open an .aqs file from the PC's hard drive by using the command *File* → *Open*. The .aqs files can be found by following the path determined in the *Settings* menu or somewhere else on the PC's hard drive. To save an .aqs file click *File* → *Save* or *File* → *Save as*.

4.3 Uploading configurations

There are several ways to write changes you have made to your relay configuration. The two most common ways are *Write to relay* and *Write changes*.

4.3.1 Write to relay

The following window appears when you click on the *Write to relay* command (in *Commands* menu). In order to be able to open this window, you need to have a connection to a relay.

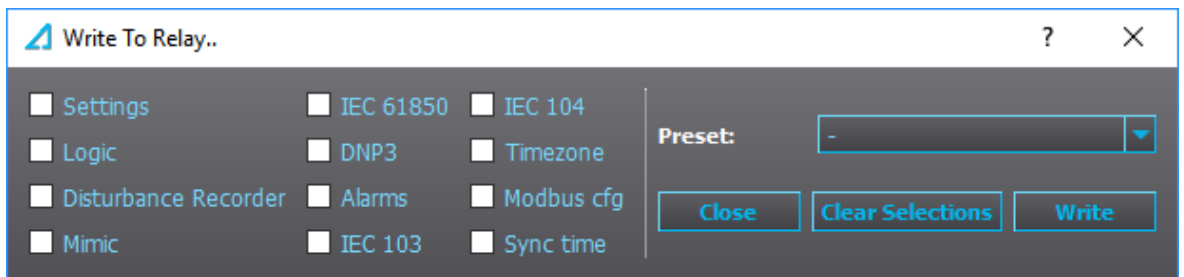

By clicking the various boxes you can choose which parts of the configuration you want to upload. You can also opt to use one of the presets (*Configuration* or *Everything*). The following list explains what each of these configuration boxes does.

- **Settings:** Includes all parameter values. Parameter values include e.g. protection pick-up levels, trip delay times, LED/DI/DO namings, IP settings, etc.

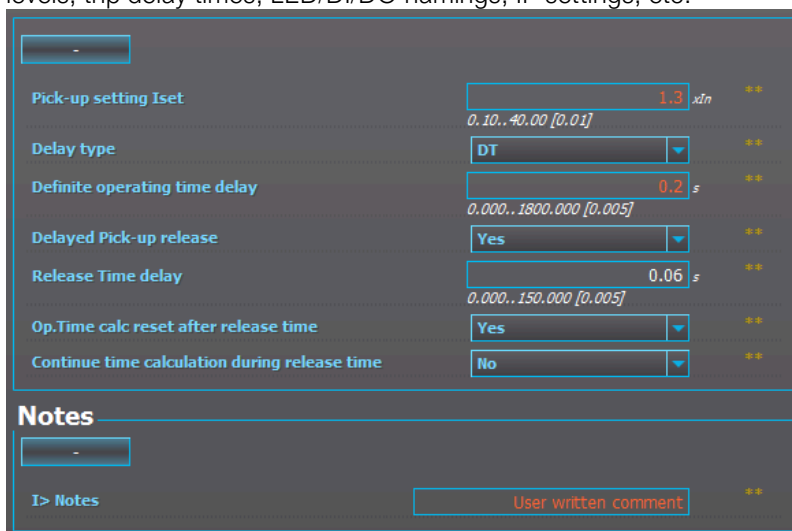

- **Logic:** Includes configurations made to the matrix, the control blocks and the logic editor.

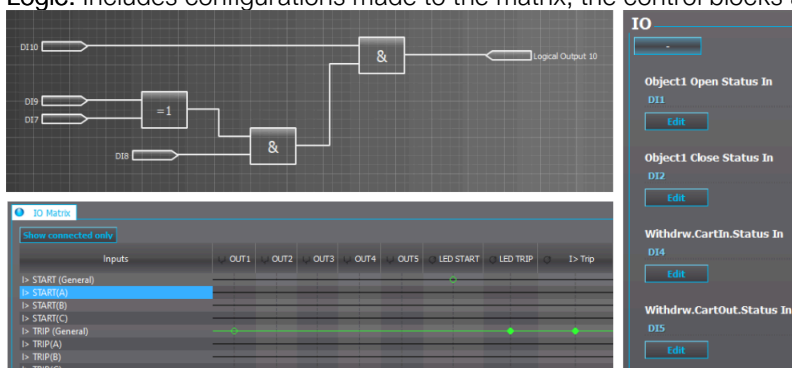

- **Disturbance recorder:** Turns on the uploaded disturbance recorder settings set at *Monitoring* → *Disturbance recorder*. Uploading disturbance recorder settings requires that logic and parameters are also uploaded.
- **Mimic:** Uploads the mimic and the carousel designs to the relay in use at *Tools* → *Mimic editor* and *Tools* → *Carousel designer*.
- **IEC61850:** Uploads the .CID file currently in use at *Tools* → *Communication* → *IEC61850*.
- **DNP3:** Uploads the DNP3 settings currently in use at *Tools* → *Communication* → *DNP3*.
- **Alarms:** Uploads the alarms settings at *Tools* → *Events and logs* → *Set alarm events*.
- **IEC103:** Uploads the IEC103 settings currently in use at *Tools* → *Communication* → *IEC103*.
- **IEC104:** Uploads the IEC101/IEC104 settings currently in use at *Tools* → *Communication* → *IEC101/IEC104*.
- **Modbus cfg:** Uploads the custom modbus configurations set up at *Tools* → *Communication* → *Modbus map*.
- **Sync time:** Syncs the relay clock to the time on the connected PC. If either serial time sync or NTP time sync is in use, these remain in use.

4.3.2 Write changes

This window displays two values for parameters: the old value that is currently in the relay, and the new value to be written to the relay (see the image below). When the *Write changes* box is checked, AQtivate writes the new listed parameters. This can work as an alternative for writing parameters with "Live edit" mode on or using *Commands* → *Write changes* to write parameters.

The tool also recognizes when logic or disturbance recorder settings have been changed. Activating the checkboxes selects which parts of the configuration will be written to the relay.

NOTE!



When determining changes, this tool compares the values now to what they were when the configuration was first opened (or, when changes were last written to the relay). This means that if any changes were made to a configuration file during a previous session and not uploaded to the relay, the *Write changes* tool does not recognize the changes and does not alert the user of the differences. In such a case, please use *Commands* → *Write changes* instead.

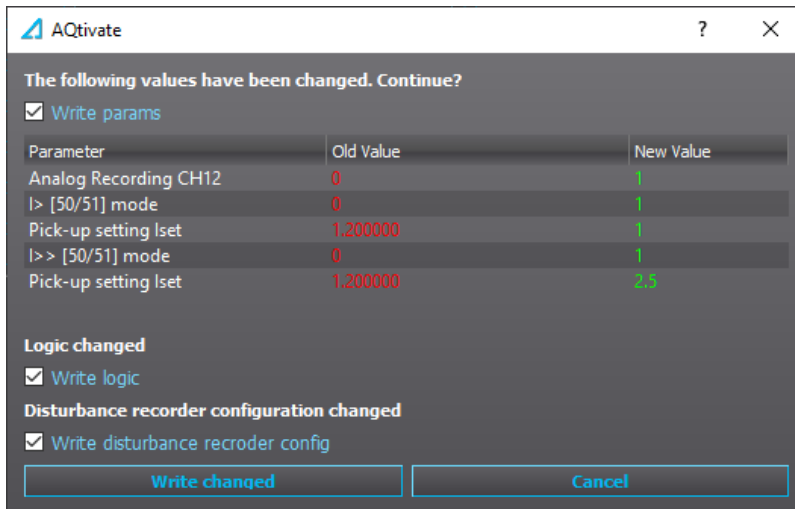

4.3.3 Live Edit

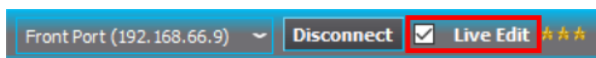

If the AQtivate setting tool is connected to the relay, you can write parameter settings to the device in real time by checking the Live Edit box (as seen in the image above). Live editing means that when you make changes to the parameters in AQtivate, they are immediately uploaded to the device. You can live edit text parameters, dropdown-box parameters and numbered parameters (see the image below for examples of these elements).

Figure. 4.3.3 - 12. Examples of elements that can be edited live.

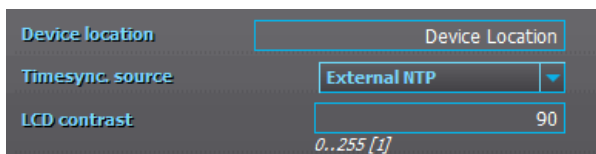

You cannot, however, edit certain other parts of the configuration such as the matrix editor, the block input and output settings, the selected input and output settings, the DR input settings, etc. When you change logic blocks, the un-synced logic blocks are highlighted with orange to remind you that they need to be uploaded to the relay (see the image below).

Figure. 4.3.3 - 13. Un-synced setting highlighted.

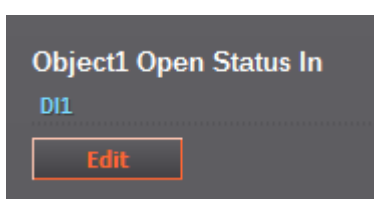

NOTE!



When you activate the Live Edit mode, AQtivate will **download** all the parameter values that are currently in use in the device to the AQtivate software. If there are any parameters that you have changed in AQtivate software while not in Live Edit mode that you wish to upload to the relay, you can do so through *Commands* → *Write changes* or *Commands* → *Write to relay*.

NOTE!



If you have made any changes to the parameters without uploading them and then go on to activate the Live Edit mode, these changes are wiped and replaced by the parameter values that are currently in use in the device.

4.3.4 Reconfiguring communication settings

When you upload new communication IP settings to the relay, a prompt appears asking whether these settings will be adopted to use immediately (see the image below).

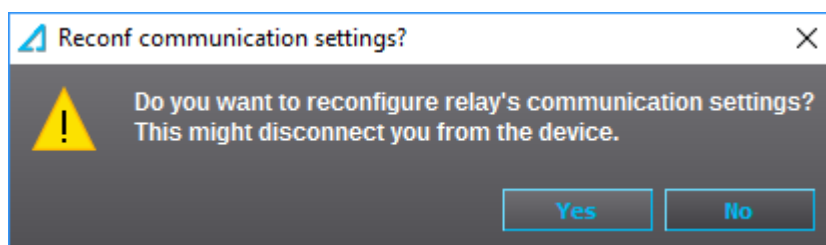

If "Yes" is selected, the new settings are adopted right away. If "No" is selected, the new IP settings will be adopted only after you have brought up the same window through AQtivate (*Commands* → *Reconf communication settings*) and clicked "Yes". If the unit is rebooted before the reconfiguration is done, the unit will revert back to the original IP address.

5 Online Edit menus

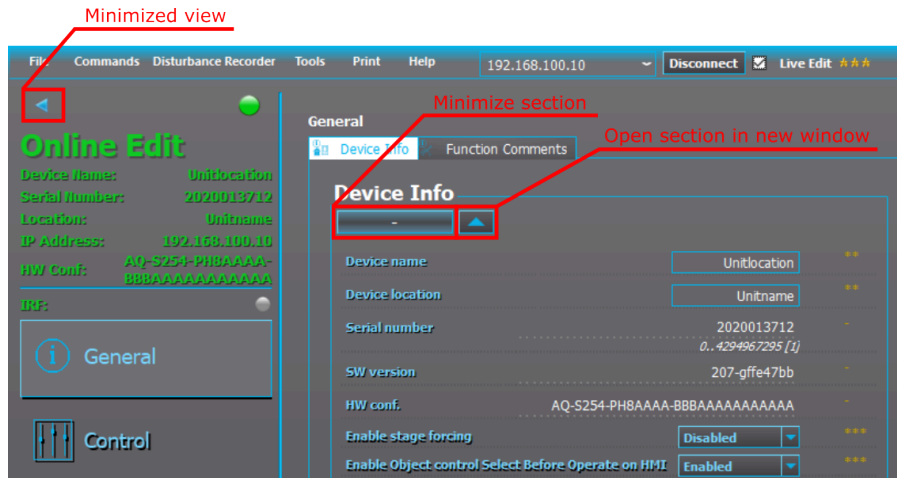

5.1 Introduction and navigation

After you open an .aqs file, menus appear to the left side of the AQtivate window. The number of these menus depends on the device type. All the settings and values that reside under these menus can also be accessed via the device's HMI display.

Every menu is divided into tabs which can be seen at the top of the the window right below the selected menu's title. You can change how things are displayed through the *Appearance* settings (for a more detailed description, see "Appearance" under the chapter "Getting started").

NOTE!



This chapter is to help you to get familiar with navigating AQtivate and with setting up the relay. For the complete descriptions of the various protection functions and other functions please refer to the relay manuals (can be downloaded at arcteq.fi/downloads/).

Drop-down menu

You can change the value of a drop-down menu by clicking it and selecting one of the options, or by placing the cursor on it and scrolling through the options with the mouse wheel (please note that this feature must be enabled first at *Tools* → *Settings* → *General* → "Allow mouse scrolling on combo boxes"). These settings can be uploaded to device with *Commands* → *Write to relay* or *Commands* → *Write changes*. However, if the Live Edit mode is active, any changes to these settings are uploaded to the device automatically.

Figure. 5.1 - 14. Changing drop-down menu values.

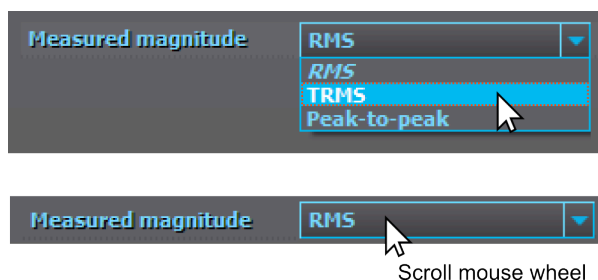

Text and number parameters

Text and number parameters can be changed by clicking on the box and writing the value or text. Press Enter-key to confirm the parameter change. To cancel the change click elsewhere without pressing Enter-key and the parameter will return to the original value or text.

Number parameters always have some limitations to what values can be set. The range of the setting for each parameter is displayed below its text box. The minimum step for the parameter is in the square brackets. For instance, in the example image below, the unit of the parameter is seconds (s), the minimum setting value is 0 seconds, the maximum setting value is 1800 seconds, the minimum step is 0.005 seconds, and the currently used setting value is 0.04 seconds.

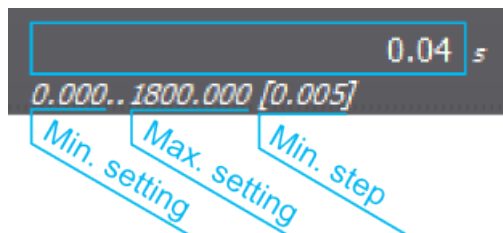

These settings can be uploaded to the device with *Commands* → *Write to relay* or *Commands* → *Write changes*. If the Live Edit mode is active, these settings are uploaded to the device automatically.

Control blocks

Control blocks control the behaviour of the device with binary signals. Click on the "Edit" button and a selection window will appear. The box at the top of the window can be used to filter the signal list to find the needed signal easier. While some control blocks allow multiple signals to be assigned to control block, some might allow only one. Use "Clear" button to clear all selected signals. "OK" button confirms the changes and "Cancel" keeps the old settings.

To use the changes made to the control blocks, please upload "Logic" to the device either with *Commands* → *Write to relay* or *Commands* → *Write changes*.

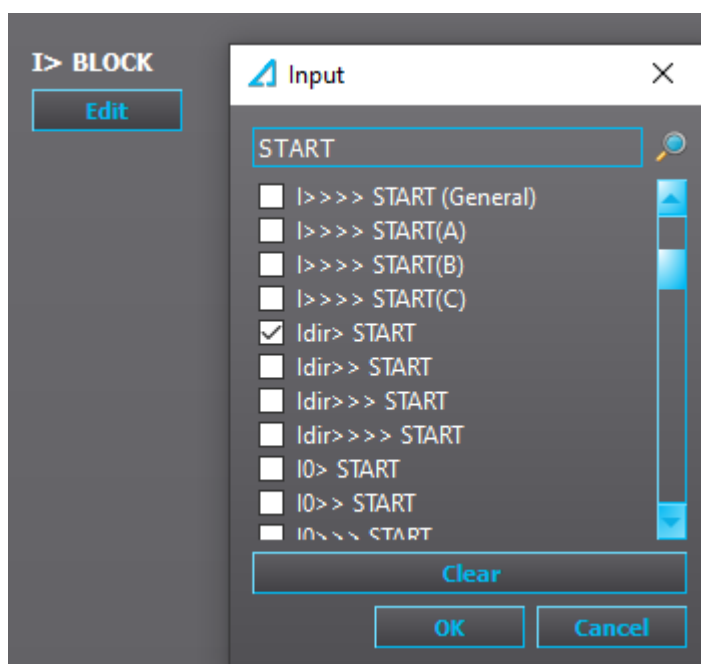

Matrix

Matrixes can be used for connecting binary signals produced by the device to control either digital output contacts or light up LEDs. To make a connection click on the matrix and choose the type of connection needed from the list. Signals to digital outputs can be either "Connected" or "Latched". When a signal is "Connected" the digital output activates and deactivates with the signal. When a signal is "Latched" the output activates with the signal but deactivates only when user presses the "Back" button on the devices front panel.

AQ-210 series user LEDs follow the same operation logic as digital outputs previously described. The color (green and yellow) can be chosen from *Control* → *Device IO* → *LED Settings* → *LED Color Settings* menu.

To use the changes made to the matrix, please upload "Logic" to the device either with *Commands* → *Write to relay* or *Commands* → *Write changes*.

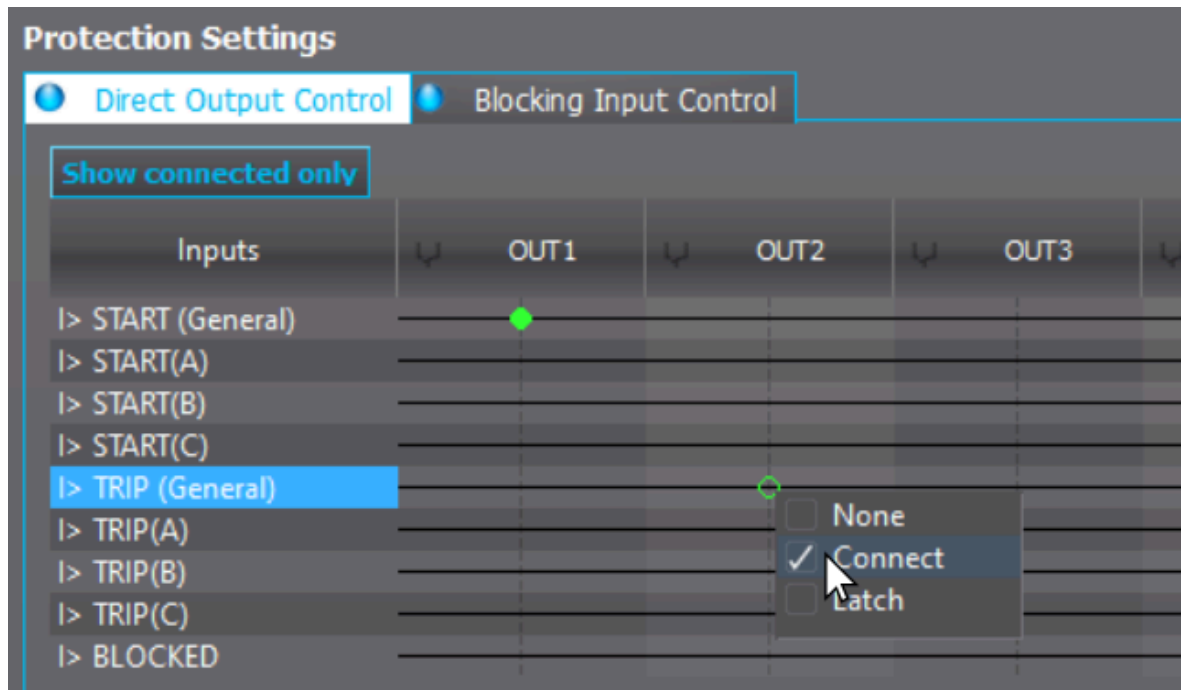

AQ-250 series device digital outputs follow the same programming logic as AQ-210 although the user LEDs are a little bit different. The color of the user LED is defined when connecting the signals (see the image below).

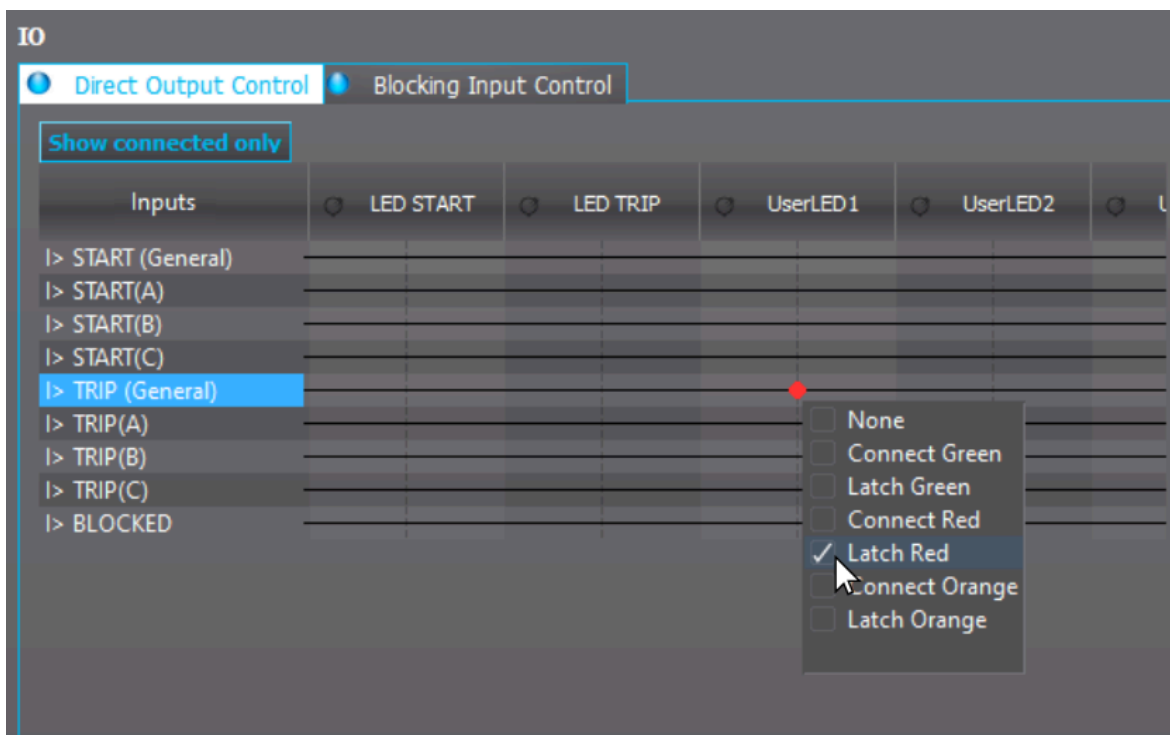

5.2 General menu

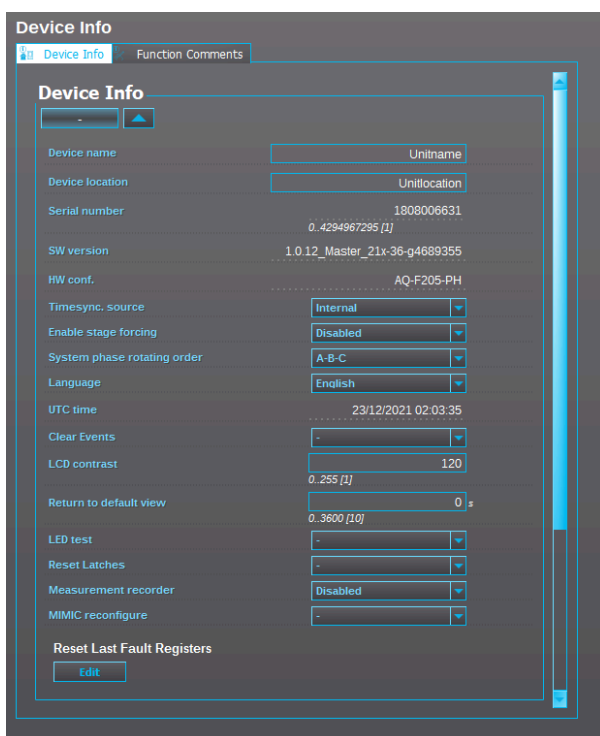

The *General* menu's *Device info* tab consists of basic information about the relay:

- **Device name:** The unit name set by the user. This name will be included in the .aqs configuration file name when the file is loaded from the relay.
- **Device location:** The unit location set by the user. This name will be included in the .aqs configuration file name when the file is loaded from the relay.
- **Serial number:** Unique serial number for identification purposes. Does not inhibit you from loading the same file to another unit with the same hardware and software.

- **SW version:** The software version in use.
- **HW conf.:** The hardware configuration. Hardware and software order code of the unit.

The tab also has some basic settings available:

- **Timesync. source:** Chooses whether the internal clock is used or whether the time is synchronized via NTP or a serial protocol (see the section "Commands menu" and its subsection "Time settings").
- **Enable stage forcing:** (See the section "Stage forcing" below.)
- **Enable object control confirmation:** When enabled, the relay asks for confirmation after a control command has been given to an object through the HMI mimic before executing the command.
- **System phase rotating order at the moment:** Displays the system phase rotating order used at this moment. Can be either A-B-C or A-C-B.
- **System phase rotating order setting:** Sets the system phase rotating order.
- **Language:** Chooses the language used by the relay (see the section "Commands menu" and its subsection "Uploading language files").
- **UTC time:** Time of the relay's clock in UTC format (Coordinated Universal Time).
- **Clear events:** Clears events recorded into relay.
- **LCD contrast:** Adjusts the contrast of the liquid-crystal display (LCD). Available in the AQ-210 series relays.
- **Display brightness:** Adjusts the screen brightness to be brighter (up to 8) or dimmer (down to 0). By default it is at 4. Available in the AQ-250 series relays.
- **Return to default view:** The time (in seconds) how long it takes for the relay to return to the default view from the mimic view. If the delay is set to 0 s (as is the default), the relay will not go back to the mimic view automatically.
- **Reset latches:** An alternative to using the **Back** button in the front panel of the relay. Resets all activated latched signals.
- **Measurement recorder:** Enables Measurement recorder function. See chapter Measurement recorder for detailed information about the function.
- **I/O Default object selection:** Defines which object open/close status I and O button LEDs follow in the front panel of the relay.

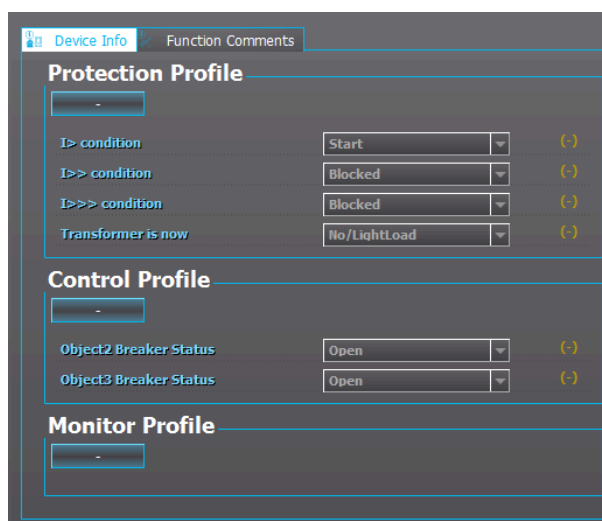

If the Live Edit mode is activate, you can quickly check the state of the protection stages and the status of the objects in use from the *Protection*, *Control* and *Monitor* profiles at the bottom of the *General* menu.

Stage forcing

In AQ-200 series relays you can test the protection system's logic and operation by controlling the state of the protection functions manually without feeding any current or voltage into the relay. To enable stage forcing, set the "Enable stage forcing" to "Enabled" in the *General* menu. After stage forcing has been enabled, you can control the status of a protection function (Normal, Start, Trip, Blocked, etc.) in the *Info* tab of any protection function. The image below shows an example of stage forcing with the I> function.

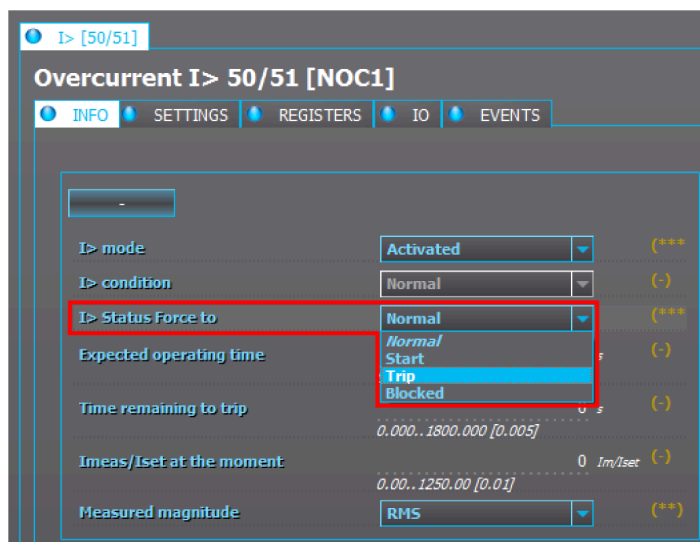

NOTE!



Protection functions remain operational while stage forcing is enabled. Please disable stage forcing in the *General* menu to ensure the relay's normal operation after testing.

Function comments

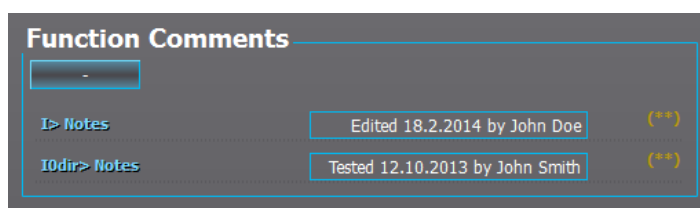

You can write comments for activated functions in the *Function comments* tab in the *General* menu. For example, you can write notes when you parameters were last changed (see the image above). You can also write comments in the functions' own *Settings* menu.

5.3 Protection menu

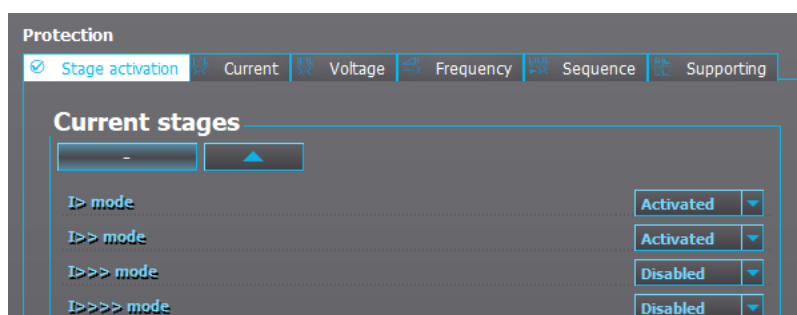

The *Stage activation* tab is the main tab in the *Protection* menu. Here you can activate and disable protection functions. The available protection functions in the configuration depends on the device type. After you have activated a function, its parameters and other information can be found by navigating to its tab. For example, if you activated the *I>* function (the overcurrent function) found listed under "Current stages" in the stage activation menu, you are able to access its settings from the *Current* menu. Each activated function has the following subsections or tabs.

Info tab

After a function has been activated, opening the function's menu automatically opens into the function's *Info* tab. The *Info* tab displays information related to the function such as statistics on starts and trips, measurements and the active settings. Additionally, this is where you can control status forcing if stage forcing has been enabled in the *General* menu.

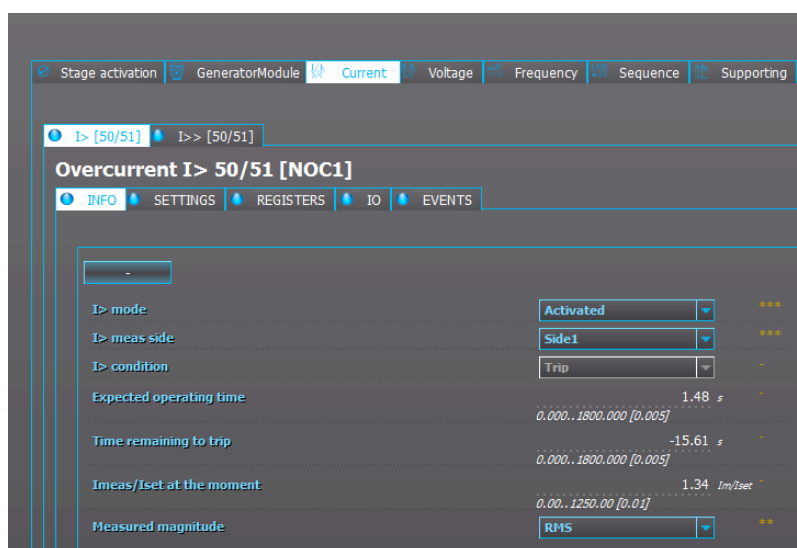

- **Setting control from comm bus:** Some functions allow you to enable setting changes through a remote connection (SCADA).
- **Meas. side:** If the unit has more than one current measurement card, some functions may require you to choose which card the relay supervises.
- **Condition:** Displays the status of the function if the Live Edit mode is activated. Otherwise, it displays the status of the function when the .aqc file was saved.
- **Phases condition:** Some functions display status of each phase (start and trip).
- **Expected operating time:** Displays the expected operating time with the measured values at that time. Especially useful when testing inverse curve delays.
- **Time remaining to trip:** Displays how much time remains to the next trip with the currently measured values.
- **X_{meas}/X_{set} at the moment:** Displays the ratio between the measured value and the set operating level at that moment. When the measured value is exactly at the operating level, a value of 1.00 is displayed for X_{meas}/X_{set} .
- **Measured magnitude:** Some functions give you the option of choosing the measured magnitude (usually this is a choice between RMS values, TRMS values and peak-to-peak values).

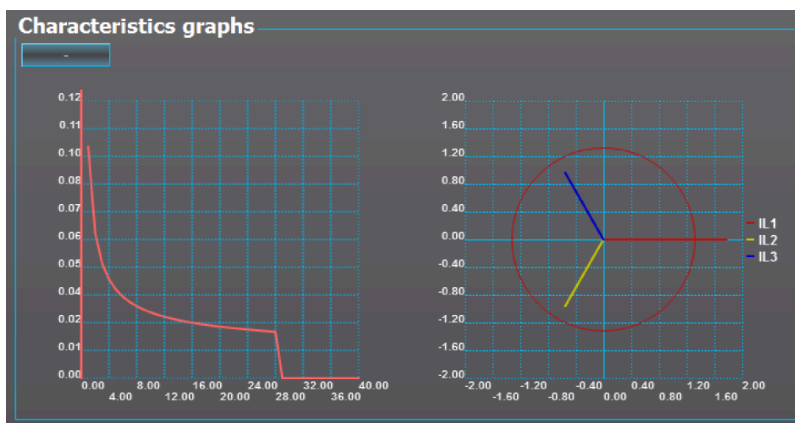

The "Characteristics graphs" section of the *Info* menu is found in most of the protection functions. The graph gives us useful information on the settings currently in use. If the Live Edit mode is activated, the graph also shows us visual information of the function's status at a given moment. In the example above, the image on the left shows the time delay settings in a graph form. The image on the right shows a vector graph of the measured currents vs. the pick-up level.

Settings tab

You can change the settings of the function in the *Settings* tab. The range of the setting for each parameter is displayed below its text box. The minimum step for the parameter is in the square brackets. For instance, in the example image below, the unit of the parameter is seconds (s), the minimum setting value is 0 seconds, the maximum setting value is 1800 seconds, the minimum step is 0.005 seconds, and the currently used setting value is 0.04 seconds.

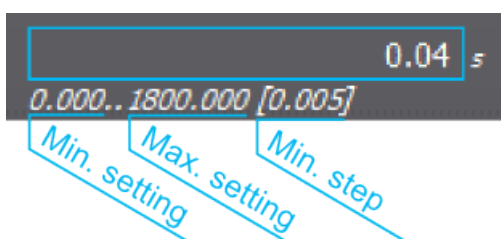

NOTE!



You can find the instructions for setting up each individual protection function from the device's manual, under the section describing the protection function in question. The latest manuals can be downloaded at arcteq.fi/downloads/.

Registers tab

	Event	Time	Fault type	Phase A pretrg curre	Phase B pretrg curre	Phase C pretrg curre	Phase A fault curre	Phase B fault curre
1	Start ON	09.04.2014 14:12:58.368	B-C	0.000000	0.000000	0.000000	0.833210	1.930672
2	Trip ON	09.04.2014 13:47:59.719	B-C	0.843087	1.913981	1.663646	0.842506	1.915640
3	Trip ON	09.04.2014 13:29:22.344	B-C	0.878737	1.878834	1.815488	0.839208	1.855971
4	Trip ON	09.04.2014 13:22:40.622	B-C	0.910107	1.890388	1.778381	0.877942	1.896433
5	Start ON	09.04.2014 12:31:20.903	B-C	0.845358	0.852911	0.842890	2.051532	2.058719
6	Start ON	09.04.2014 12:30:44.833	B-C	0.844305	0.853372	0.842448	0.845010	1.945212
7								
8								
9								
10								
11								
12								

The *Registers* tab contains two views: *Operation event register* and *General event register*. *Operation event register* displays information about the function's alarms and trips. The tab only displays the measurement values that are relevant to the actual function. Each function registers its operation into the last twelve (12) time-stamped registers. The values recorded into registers contain information such as the time stamp, the fault type, the pre-triggering measurement value, the fault measurement value, etc. You can find a more detailed explanation of what each of the register columns records in the device's manual (under the selected protection function's chapter, in the section titled "Events and registers"). The manuals can be downloaded from arcteq.fi/downloads/.

When you open an .aq5 configuration that has been downloaded from the relay, AQtivate displays the registers recorded to the .aq5 at the moment of downloading. If the Live Edit mode has been activated, AQtivate displays the registers in real time.

To clear the registers, select "Clear" in the "Clear registers" drop-down menu that is located below the table.

Seq	Code	Name	Timestamp
1735	1283	NOC1: Trip OFF	13.12.2021 02:51:13.371
1734	1281	NOC1: Start OFF	13.12.2021 02:51:13.371
1733	1297	NOC1: Phase C Trip Off	13.12.2021 02:51:13.366
1732	1295	NOC1: Phase B Trip Off	13.12.2021 02:51:13.366
1731	1293	NOC1: Phase A Trip Off	13.12.2021 02:51:13.366
1730	1291	NOC1: Phase C Start Off	13.12.2021 02:51:13.366
1729	1289	NOC1: Phase B Start Off	13.12.2021 02:51:13.366
1728	1287	NOC1: Phase A Start Off	13.12.2021 02:51:13.366
1724	1296	NOC1: Phase C Trip On	13.12.2021 02:44:07.478
1723	1294	NOC1: Phase B Trip On	13.12.2021 02:44:07.478
1722	1292	NOC1: Phase A Trip On	13.12.2021 02:44:07.478
1721	1290	NOC1: Phase C Start On	13.12.2021 02:44:07.478
1720	1288	NOC1: Phase B Start On	13.12.2021 02:44:07.478

General event register displays events recorded by the function. The relay records any event that has been activated in the *Events* tab. These events can be also viewed at *Tools* → *Events and logs* → *Event history*.

I/O tab

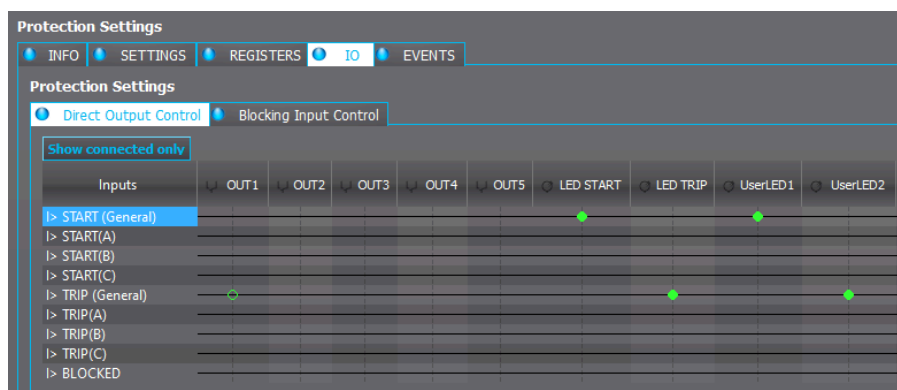

The *I/O* tab is divided between the *Direct output control* tab and the *Blocking input control* tab.

In *Direct output control* the function's output signals can be used to switch output the statuses of signals and user LEDs ON or OFF. The available output signals vary depending on the function. The matrix has two kinds of connections for output contacts: "Connected" and "Connected and latched". The connected output is activated (or released) when the input is activated (or released). Similarly, the latched connection output signal is activated when the input is activated; however, the output remains active until it is cleared manually from the device's panel by pressing the **Back** button. A latched signal can also be reset by remote terminal unit. See the diagram below describing the difference between normal and latched signals.

Click on the crossing point of an input signal and an output signal to make a connection. Then choose "None", "Connect", or "Latch".

Figure. 5.3 - 15. Behaviour of normal and latched signals.

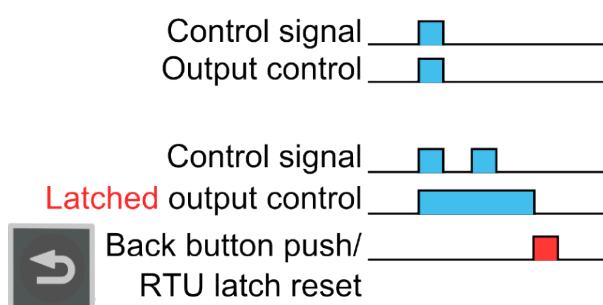

In AQ-25x series devices you can choose the color of the LED when making the matrix connection. The available colors are *green*, *red* and *orange*.

When the matrix has been configured, upload the logic with *Commands* → *Write to relay*.

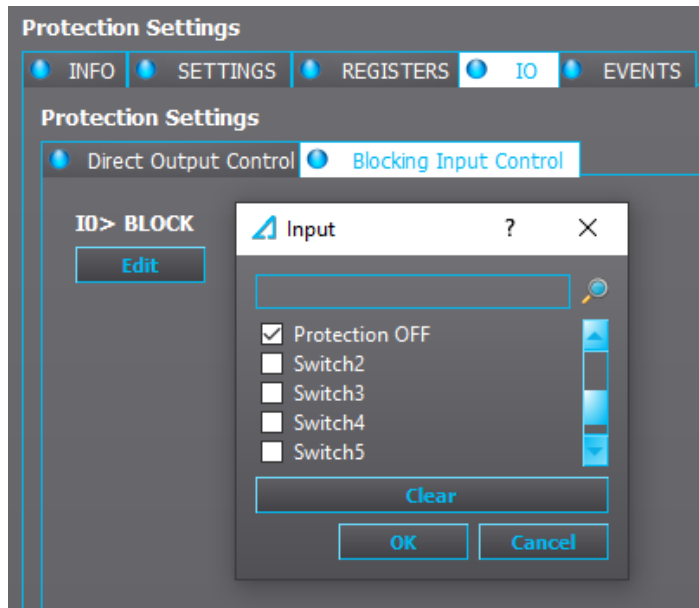

The *Blocking input control* tab is used to determine which signals block the function. By default no signals block any function. Click *Edit* at the bottom of the window to set the blocking signals of the function. A list of different signals appears. In the example image above, we are setting up signals that would block the IO> (earth fault) function. The *Protection OFF* signal (a renamed, programmable control switch) is connected which means that whenever this signal is true, the IO> stage is blocked. The logic must be uploaded to the relay (*Commands* → *Write to relay*) for the changes to take effect.

Events tab

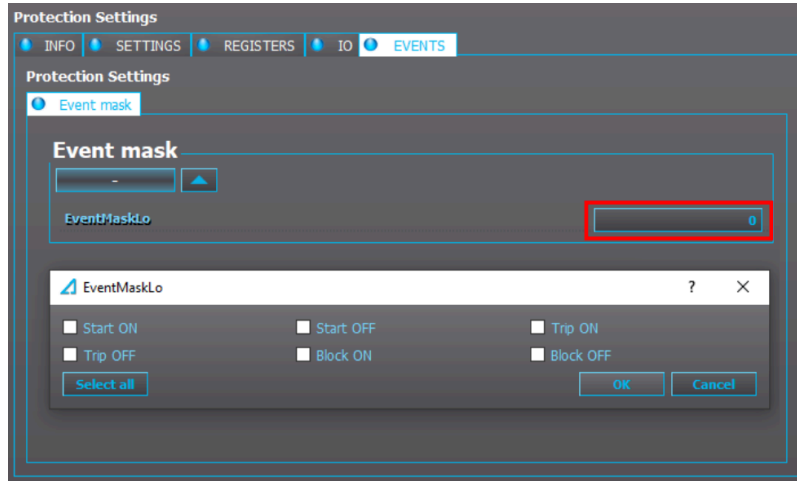

You can select which events are recorded into the *Event history* by setting the *Event mask* dialog. To set the *Event mask* dialog, click on the number box. A pop-up window appears where you can select which event types are recorded. After this the recorded events will show up in the *Event history* (*Tools* → *Events and logs* → *Event history* or the shortcut **Ctrl+Shift+E**). The recorded events can also be checked in the HMI if the *Events* screen has been applied to the carousel (see *Tools* → *Carousel Designer* for more information).

5.4 Control menu

5.4.1 Controls enabled

The *Controls enabled* tab is the main view of the *Control* menu, and it is used to activate and disable control functions, controllable objects and indicators. Once the functions are activated they can be adjusted in the *Control functions* tab. Objects and indicators can be adjusted in the *Objects* tab.

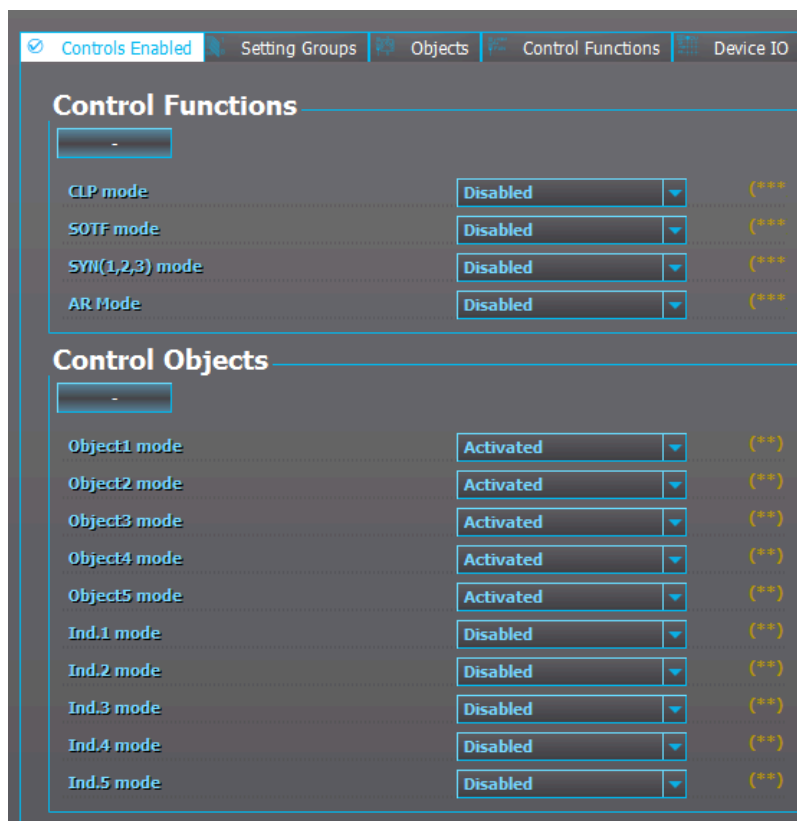

5.4.2 Setting groups

In the *Setting groups* tab you can set the number of setting groups used, determine which signals set the setting groups on, and force a setting group change. The "SG local select" subsection determines which digital inputs or logical signals set the setting groups on. The new setting group configuration must be uploaded to the relay (*Commands* → *Write to relay*) for the changes to take effect.

For example, let us set the "Used setting groups" from "SG1" to "SG1...4" (see the image below).

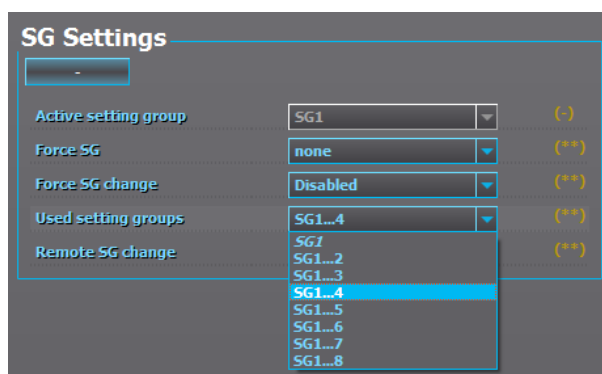

Let us see what happened to the menu of a protection function (e.g. *Protection* → *Overcurrent* → *Settings*). As can be seen in the image below, there are now four setting groups available. Note that when new setting groups are added, the parameter settings may not be the same as in the default "SG1". When a new setting group has been added for the first time, it appears with the default settings.

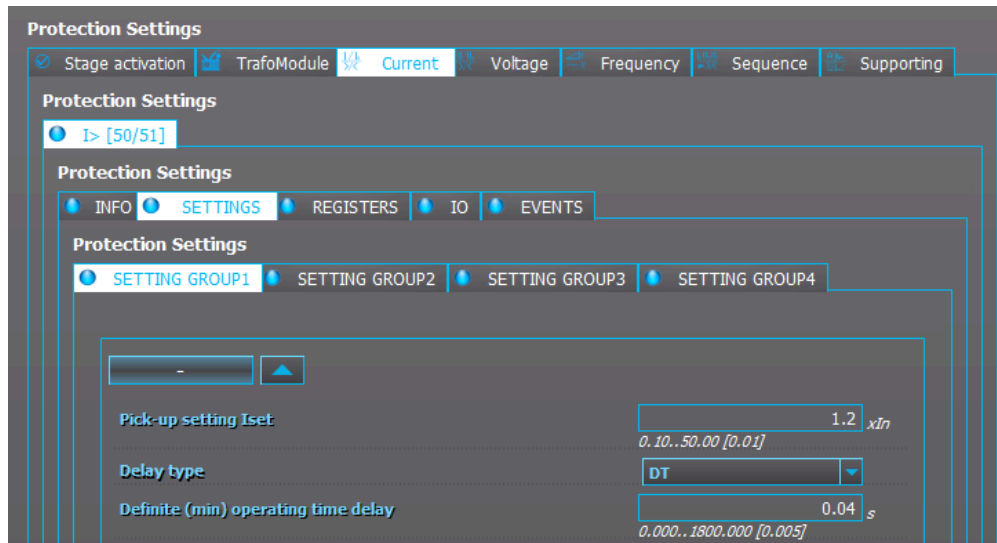

You can bypass the setting group selection logic and force the activation of a wanted setting group. This is useful, for instance, during commissioning where the tester is not able to activate the signals which would set the desired setting group into use. In the image below, "Force SG change" has been enabled and the desired setting group ("Force SG") has been set to "SG2".



5.4.3 Objects

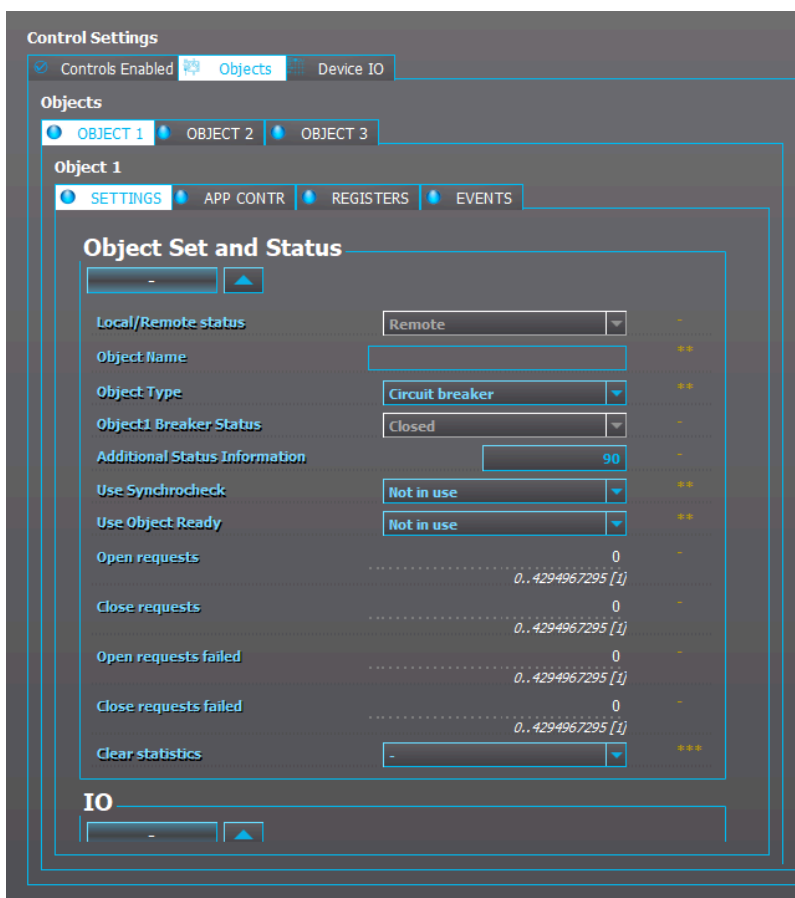

The *Objects* tab is used for setting up circuit breakers and disconnectors as well as their status information and control. An object can be applied to the HMI mimic view after it has been set up.

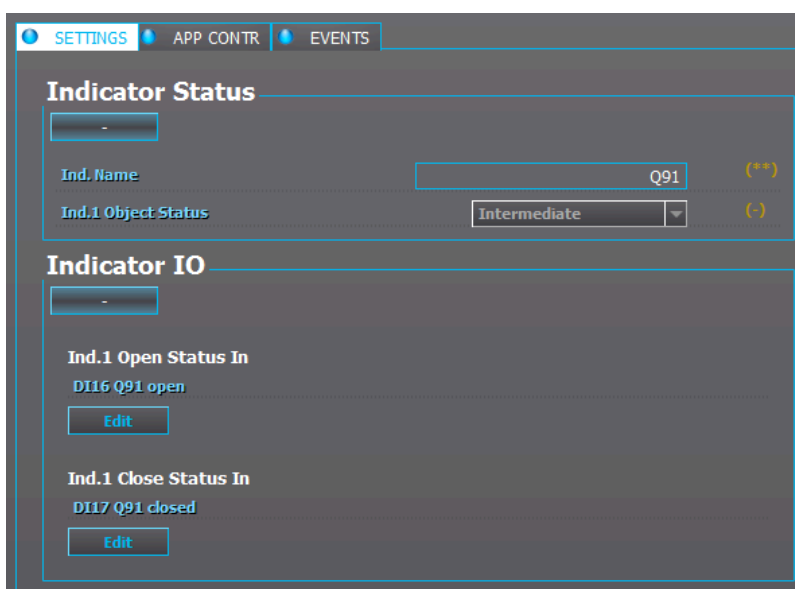

Some relays also have indicators: they can display the state of a switch but cannot receive any open or closed signals.

NOTE!



For a more detailed description on how to setup objects, please check the relay's own manual at www.arcteq.fi/downloads.

5.4.4 Control functions

This tab is used for setting up the control functions activated in the *Controls enabled* tab. You set up control functions in the same way you set up protection functions.

5.4.5 Device I/O tab

Digital input and output settings

The *Digital input settings* include the following digital input settings (see the image below):

- the polarity
- the activation and release threshold voltage levels
- the activation and de-activation delays
- DI AC mode enables and disables the 30-millisecond delay that accounts for alternating current.

DI4 Polarity	NO
DI4 Activation th	88 V 5.0..240.0 [0..1]
DI4 Release th	60 V 5.0..240.0 [0..1]
DI4 Act Del	0 s 0.000..1800.000 [0.001]
DI4 Drop-off time	0 s 0.000..1800.000 [0.001]
DI4 AC Mode	Disabled
DI4 Counter	0 0..4294967295 [1]
DI4 Counter Clear	-

The *Digital output settings* are for setting the outputs between normally open (NO) and normally closed (NC).

You can change the descriptions of both inputs and outputs; this helps you differentiate the various signals from one another when making configurations.

LED settings

In the LED settings you can change the descriptions of the user LEDs (see the image below). Additionally, you can set the color of those LEDs (green or yellow) when configuring AQ-210 series units. In AQ-250 series units the color of the LED is chosen when you connect signals to the LEDs in the matrix. The color priority defines which color is lit up if two or three colors are activated for the same LED.

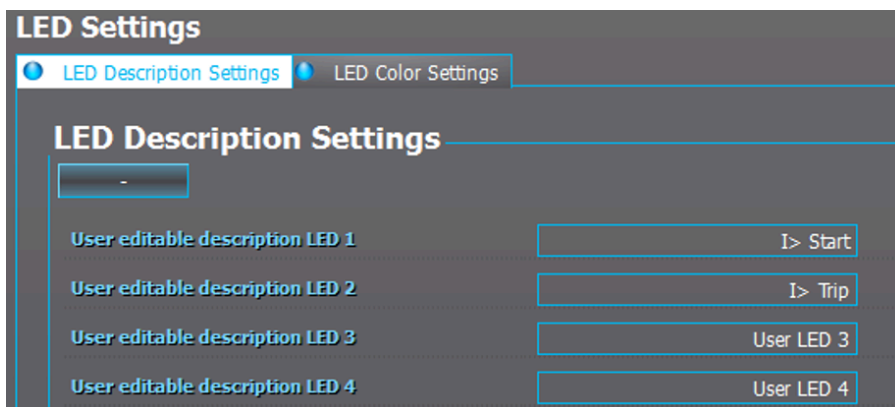

Device I/O matrix

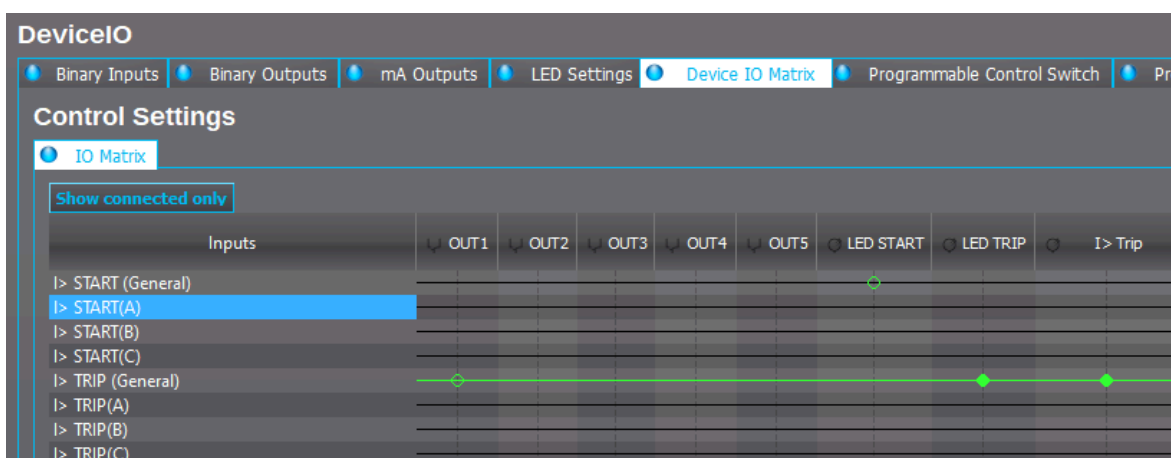

The *Device I/O matrix* tab displays the full I/O matrix of the device (see the image above). Any I/O connections made to any of the functions can also be seen here. Additionally, whenever connections are made in the I/O matrix table, those changes can be seen in the function's I/O matrix table (*Protection* → the function's I/O tab). When the Live Edit mode is on, the status of an active signal is displayed with a green line (see the image above).

Whenever changes are made to the *Device I/O matrix*, the logic in the device is no longer up to date. The logic needs to be updated into the relay so that the changes take effect (*Commands* → *Write to relay*).

The available output signals vary depending on the device type.

Figure. 5.4.5 - 16. Behaviour of normal and latched signals.

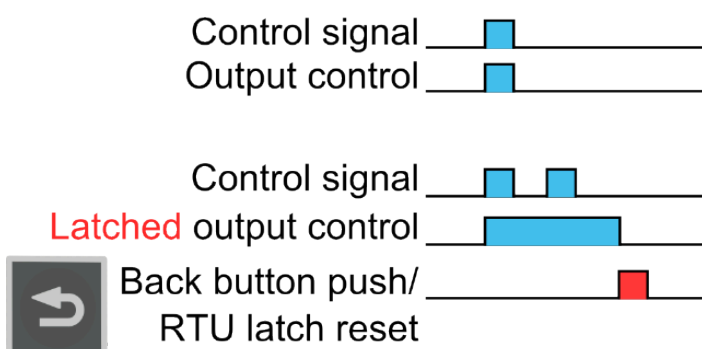

The matrix has two kinds of connections for output contacts: "Connected" and "Connected and latched". The connected output is activated (or released) when the input is activated (or released). Similarly, the latched connection output signal is activated when the input is activated; however, the output remains active until it is cleared manually from the device's panel by pressing the **Back** button. A latched signal can also be reset by a remote terminal unit. See the diagram above describing the difference between normal and latched signals.

Click on the crossing point of an input signal and an output signal to make a connection. Then choose "None", "Connect", or "Latch".

When configuring an AQ-21x series device LED assignments, you can set the color of the LED (*Control* → *Device I/O* → *LED settings*). In AQ-25x series devices you can choose the color of the LED when making the matrix connection. The available colors are green, red and orange. If two or more signals are attempting to activate different colors to the same LED, the displayed color depends on the priority that you have set (*Control* → *Device I/O* → *LED settings*).

5.5 Communication menu

Communication menu is used for setting up the basic settings for connecting to unit with setting tool and RTUs.

5.5.1 Connections

The *Connections* tab consists of the Ethernet IP address settings and the RS-485 serial communication settings, both located in the back panel.

Ethernet

The Ethernet IP address settings define what IP address the Ethernet port uses. If an Ethernet-based communication protocol is used, this IP address is used for that as well. Additionally, this section displays the device's MAC address. You can enable Ethernet-based communication protocols (such as IEC 61850, Modbus TCP, etc.) at *Communications* → *Protocols*.

Virtual Ethernet

Virtual Ethernet enables the device to be connected to multiple different networks simultaneously via one physical Ethernet connection. Virtual Ethernet has its own separate IP address and network configurations. All Ethernet-based protocol servers listen for client connections on the IP addresses of both the physical Ethernet and the Virtual Ethernet.

You can enable the Virtual Ethernet connection in the *Virtual Ethernet* section. You can also edit its IP address, netmask, and gateway there.

Serial COMx

In this section you can define the basic settings used by serial communication ports. You can select the serial communication protocol if one is used by this port. Further communication protocol settings can be done at *Communications* → *Protocols*.

5.5.2 Protocols

This tab mostly consists of communication protocol enabling, slave addresses, measurement intervals etc. Available settings depend on the communication protocol.

NTP

If NTP time synchronization is used, the server and client settings are defined here. Please note that in order to use time synchronization with NTP, the "Timesync. source" parameter in the *General* menu should be set to "External NTP". When the device time is synchronized, the "NTP quality for events" parameter in this tab changes from "Not synchronized" to "Synchronized".

IEC 61850/GOOSE

This tab is used as a starting point for configuring IEC 61850 settings. The settings include the enabling of IEC 61850 and/or GOOSE subscription, GOOSE input settings and measurement deadbands. After these have been set up, further settings can be done via *Tools* in the AQtivate main toolbar (*Tools* → *Communication* → *IEC 61850*).

Modbus/TCP

In this tab you can only enable the Modbus/TCP protocol and define the IP port for the communication. All further settings can be done via *Tools* in the AQtivate main toolbar (*Tools* → *Communication* → *Modbus map*).

Modbus/RTU

In this tab you can only set up the Modbus/RTU slave address. You can enable the Serial Modbus/RTU at *Communication* → *Connections*. All further settings can be done via *Tools* in the AQtivate main toolbar (*Communication* → *Modbus map*).

IEC 103

In this tab you can only set up the slave address and the measurement update interval. You can enable the IEC 103 protocol at *Communication* → *Connections*. All further settings can be done via *Tools* in the AQtivate main toolbar (*Tools* → *Communication* → *IEC 103*).

IEC 101/104

The standards IEC 60870-5-101 and IEC 60870-5-104 are closely related, as both are derived from the IEC 60870-5 standard.

On the physical layer IEC 101 uses serial communication, whereas IEC 104 uses Ethernet communication. If the IEC 101 protocol is used, it can be activated at *Communication* → *Connections*. If the IEC 104 protocol is used, it can be activated at *Communication* → *Protocols* → *IEC 101/104* (i.e. this tab). Both IEC 101 and IEC 104 share the measurement deadband settings and the scaling coefficients. All further settings can be done via *Tools* in the AQtivate main toolbar (*Tools* → *Communication* → *IEC101/IEC104 Map*).

SPA

In this tab you can only set up the SPA address and choose whether or not time synchronization is used. You can enable SPA at *Communication* → *Connections*. The SPA map can be found at *Tools* → *Communication* → *SPA map* through AQtivate's main toolbar. The SPA event list can be found at *Tools* → *Events and logs* → *Event list*.

DNP3

DNP3 is supported in both the serial mode and the TCP (Ethernet) mode. To use DNP3 in the serial mode, it must be activated at *Communication* → *Connections*. If DNP3 is used in the TCP mode, it must be activated at *Communication* → *Protocols* → *DNP3*. Further settings can be found at *Tools* → *Communication* → *DNP*.

Modbus I/O

The *Modbus I/O* tab is used for RTD and mA measurements with external ADAM modules connected to the RS-485 port. Using ADAM modules requires that the Modbus I/O protocol is selected at *Communication* → *Connections*.

5.5.3 General I/O

The *General I/O* tab has twelve (12) fault registers that can be set up to record the following signals:

- I>, I>>, I>>> and I>>>> (non-directional overcurrent) fault values of each phase individually
- Io>, Io>>, Io>>> and Io>>>> (non-directional earth fault) residual current values
- Id>, Id>>, Id>>> and Id>>>> (directional overcurrent) fault values of each phase individually
- lod>, lod>>, lod>>> and lod>>>> (directional earth fault) residual current values
- FLX (fault locator) value

Each of these can be set to be triggered by the TRIP signal, by the START signal, or by both START and TRIP signals. These registers can be read through SCADA for fault analyzing.

5.5.4 Real-time signals to communication

Real-time signals to communication can be used by "Fast Modbus" to report measurement values quickly to Modbus. There are eight (8) channels available in this function. The measurements are categorized under "Currents", "Voltages", "Powers", "Impedance (ZRX) and admittance (YGB)" and "Others".

For example, if the ninth harmonic of the IL2 current measurement needs to be reported to SCADA, simply set the magnitude of one of the channels as "Currents" and "IL2 9.h". After setup this function reports these measurements to SCADA.

5.6 Measurement menu

The *Measurement* menu is used for setting up current and voltage transformer scaling and for observing different measurements and phasors. The following lists all possible measurement options; the device type in use determines which of them are available:

- Transformers (CT & VT)
- Frequency
- RTD and mA inputs
- RTD
- AI (mA, DI volt) scaling
- Current measurement
- Current component measurement
- Voltage measurement
- Power and energy measurements
- Impedance calculations
- Admittance calculations
- Phasors

Additionally, the final tab (*Measurements update*) allows for the setting of the update interval of various measurements.

NOTE!



This chapter goes through the first two measurement options, as they are the most relevant to the configuration of the Arcteq relays. If you wish to read a more detailed and technical explanation of these as well as of the other measurements, please refer to the "Measurements" chapter of the individual device's manual (can be downloaded at arcteq.fi/downloads/).

CT module

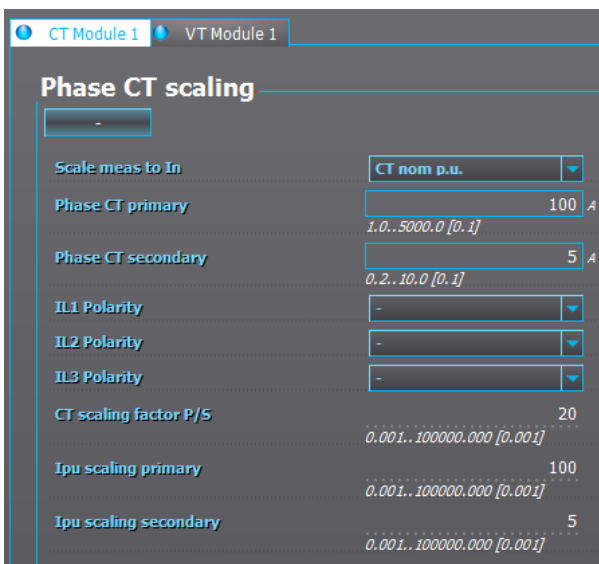

The *CT module* tab is for setting up the current transformers' primary and secondary nominal currents as well as the polarities of the channels. By default, the per unit value of current-based protection functions is scaled from the current transformers' primary nominal current. The nominal current value can also be set by selecting the "Object In p.u." option for "Scale meas. to In" and then giving a current value to "Nominal current In". A more detailed description of current measurement can be found in the device manual.

VT module

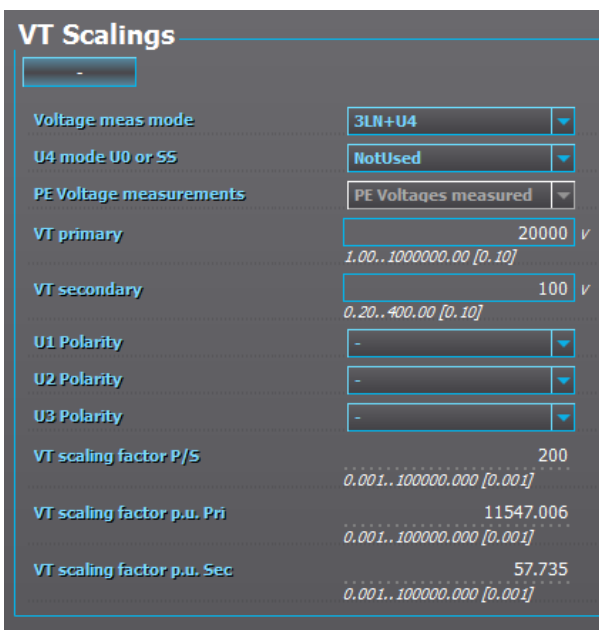

The *VT module* tab is used to set up the nominal values of voltage transformers. The only difference to current transformer settings is that you can choose from three different measurement modes (3LN+U4, 3LL+U4, or 2LL+U3+U4). Depending on which measurement mode is chosen, you can activate U3, U4 or both channels for residual voltage measurement or for synchro-checking. You can also activate voltage memory in this tab. A more detailed voltage measurement description can be found in the device manual.

Frequency

In the *Frequency* tab you select the sampling mode which determines which frequency setting is used in calculations, "Fixed" or "Tracking". If set to "Fixed", the calculations that need frequency are based on the value given in the "Sys. nom. f." (that is, the system nominal frequency) parameter; by default it is 50 Hz. If the sampling mode is set to "Tracking", the frequency will be tracked by referencing the chosen channels in "f. Refx" (that is, the frequency reference x). A more detailed frequency measurement description can be found in the device manual.

The screenshot shows the 'Freq. Settings' menu with the following parameters and values:

Parameter	Value
Smpl mode	Fixed
Sys.nom.f	50 Hz
Track.sys.f	50 Hz
Sampl.f used	50 Hz
f Ref1	CT1IL1
f Ref2	CT1IL2
f Ref3	CT1IL3
f.tr qual	Fixed freq. In use
f.meas in use	No track ch
Start behavior	St Track direct
Start smpl with	Use track f
Use nom freq until	0.1 s
Tr f CHA	0 Hz
Tr f CHB	0 Hz
Tr f CHC	0 Hz

5.7 Monitoring menu

Enabling and setting monitoring functions

The enabling and setting of monitoring functions is done the same way as with control functions and protection functions. The *Monitors enabled* tab lists the monitoring functions that the relay in question has and with the drop-down menu you can activate them at will. In the *Monitor functions* tab you can select a monitoring function and view its information and edit its settings.

Disturbance recorder

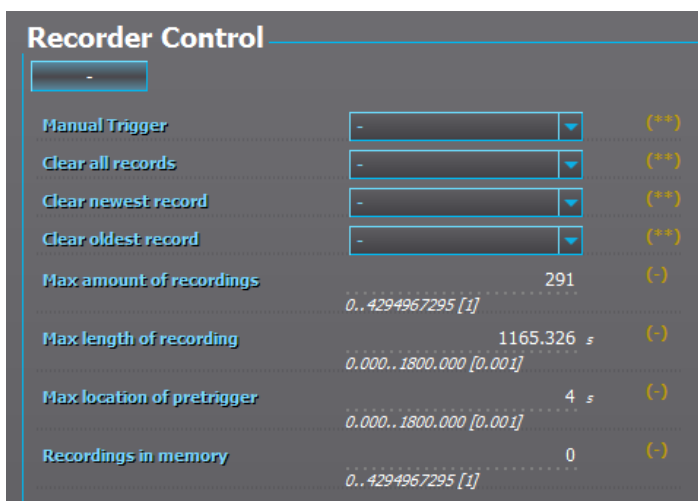

The parameter settings for the disturbance recording are done in *Monitoring* → *Disturbance REC*. When the disturbance recorder has been configured, the *Recorder Control* section displays the following: the maximum number of recordings that can be recorded into the memory, the maximum length of a recording, the maximum length of a pre-trigger recording as well as the recordings currently in memory. The table below presents some examples of how many recordings fit into a relay' s memory with different settings.

Table. 5.7 - 1. Examples of the number of recordings fit into relay memory with different settings.

	Example 1	Example 2	Example 3
Samples per cycle	64	64	64
Analog channels	8	8	8
Digital channels	24	24	24
Record duration	5 s	10 s	60 s
Total number of recordings	100	52	8

NOTE!



When setting the "Recording length", its value should not exceed the value of "Max. length of recording".

Recorder Settings

Recording length: 0.5 s
0.100..1800.000 [0.001]

Recording mode: FIFO

Analog channel samples: 64s/c

Digital channel samples: 5ms

Pre triggering time: 0.4 s
0.1..15.0 [0.1]

Analog Recording CH1: IL1

Analog Recording CH2: IL2

Analog Recording CH3: IL3

Analog Recording CH4: I01C

Analog Recording CH5: I01F

Analog Recording CH6: UL1(2)

Analog Recording CH7: UL2(3)

Analog Recording CH8: UL3(1)

Analog Recording CH9: U0(SS)

Auto. get recordings: Enabled

Rec.Digital Channels

I> START (General)

I> TRIP (General)

I> BLOCKED

Ih> START

Edit

In the example figure above the Disturbance recorder records 64 samples per cycle from the chosen nine analog channels (IL1, IL2, IL3, I01C, I01F, UL1, UL2, UL3, U0). It also records the state of the four chosen digital channels (I>START, I>TRIP, I> BLOCKED and Ih> START).

If there is a disturbance recording in the memory, you can retrieve it by clicking *Disturbance recorder* on the AQtivate main toolbar and selecting "Get DR file" from the drop-down menu. This loads the DR file as a .zip file to the folder you have set for disturbance recordings in *Tools* → *Settings*. If "Auto. get recording" has been enabled, the recordings are sent to the relays FTP server; from there the recordings can be loaded with SCADA.

Any disturbance recording file in COMTRADE format can be evaluated by launching the AQviewer software (installed with AQtivate). It can be opened by clicking *Disturbance recorder* on the AQtivate main toolbar and selecting "Launch AQviewer" from the drop-down menu.

When uploading disturbance recorder parameters and logic changes to the relay, you also need to write the "Disturbance recorder" settings (*Commands* → *Write to relay*).

Device diagnostics

Table. 5.7 - 2. Device diagnostics parameters.

Name	Range	Step	Default	Description
Diagnostic alarm status	0: Temp. out of range 1: Voltage out of range 2: HW configuration invalid 3: Relay output failure 4...9: Option card A...F alarm 10. GOOSE invalid	-	-	Displays the status of the diagnostic alarm.
Clear diagnostic alarm	0: - 1: Clear	-	0: -	Clears the diagnostic alarms.
Protection constants calculated	0: Not calculated 1: Calculated	-	-	Indicates whether or not protection constants are calculated.
Internal temperature	0.0...200.0 °C	0.1 °C	-	Displays the internal temperature of the device.
Internal voltage (24 V/24 C max/24 V min/24 V deviation)	0.0...50.0 V	0.1 V	-	Displays the internal voltage of the device: the nominal, the maximum, the minimum, and the deviation.
Full system reset	0: - 1: Reset	-	0: -	Resets the whole system of an AQ-200 series device.
Protection system reset	0: - 1: Reset	-	0: -	Resets the protection system.
Reset is pending	0.0...60.0 s	0.1 s	-	When a full system reset or a protection system reset command has been given, a countdown start. When the countdown reaches zero, the AQ-200 series device resets.
Baseboard card revision	0...2 ³² - 1	1	-	Displays the revision of baseboard card.
Baseboard card serial number	0x0...0xFFFFFFFF	0x1	-	Displays the serial number of the baseboard card.
CPU serial number	0x0...0xFFFFFFFF	0x1	-	Displays the serial number of the device's CPU. You can have up to four (4) CPUs; the serial number of each is displayed on its own row.

Name	Range	Step	Default	Description
Slot x card type	0: Reserved 1: Display 2: Current measurement 3: Voltage measurement 4: Digital input 5: Output relay 6: Arc 7: Communication 8: mA output 9: mA input 10: RTD input 11: Low energy analog 12: Digital input 13: U0 measurement 14: LC Ethernet 15: RJ 45 Ethernet 16: ST Ethernet	-	0: Reserved	Displays the card type of the selected slot (A...N).
Slot x card revision	$0 \dots 2^{32} - 1$	1	-	Displays the card revision of the selected slot (A...N).
Slot x card serial number	$0 \times 0 \dots 0 \times \text{FFFFFFFF}$	0×1	-	Displays the card serial number of the selected slot (A...N).
Internal relay fault status	0: Storage error 1: Logic file missing 2: Acquisition unit error 3: Measurement config error 4: Relay hardware setup error 5: System overload error 6: Not configured yet 7: Firmware upgrade done 8: Slot supervision error 9: Software inconsistency error 10: Safe setting mode active	-	-	Displays the internal relay fault status of the device.
Clear fault status	0: - 1: Clear	-	0: -	Clears the (internal relay fault status).
Option card health status	0: Baseboard fault 1: Card slot A fault 2: Card slot B fault 3: Card slot C fault 4: Card slot D fault 5: Card slot E fault 6: Card slot F fault	-	-	Indicates if fault on any of the cards have been detected
Logic state	0: Setup 1: Stopped 2: Running 3: Error	-	-	Indicates the status of logic.
Gates usage	0.0...100.0	0.1	-	Displays the amount of available logic gates used in percentage value.

Name	Range	Step	Default	Description
Wires usage	0.0...100.0	0.1	-	Displays the amount of logic wires used in percentage value.

6 Commands menu

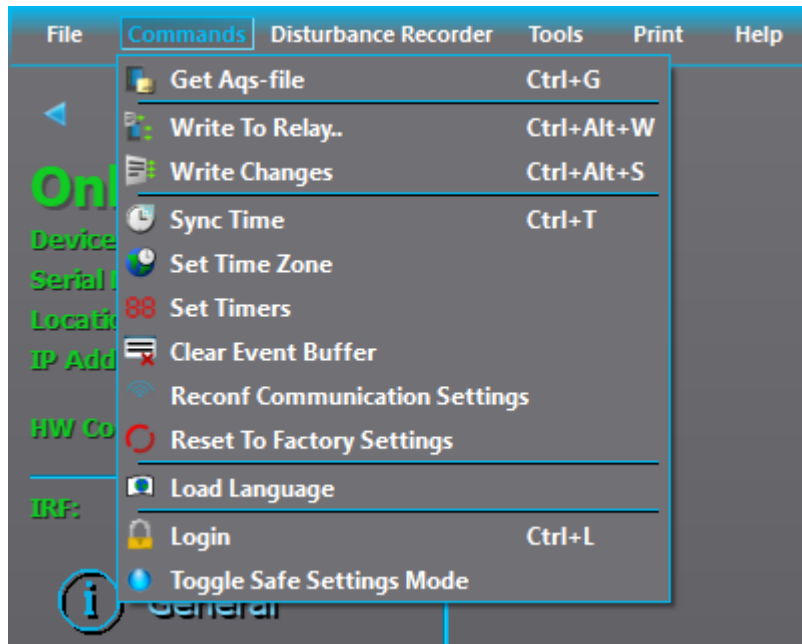

6.1 Time settings

Selecting time zone

Time synchronization with certain communication protocols require that the time zone of the device is defined. You can select the time zone for the relay: click *Commands* in the toolbar and then select "Set time zone" from the drop-down menu (see the image below).

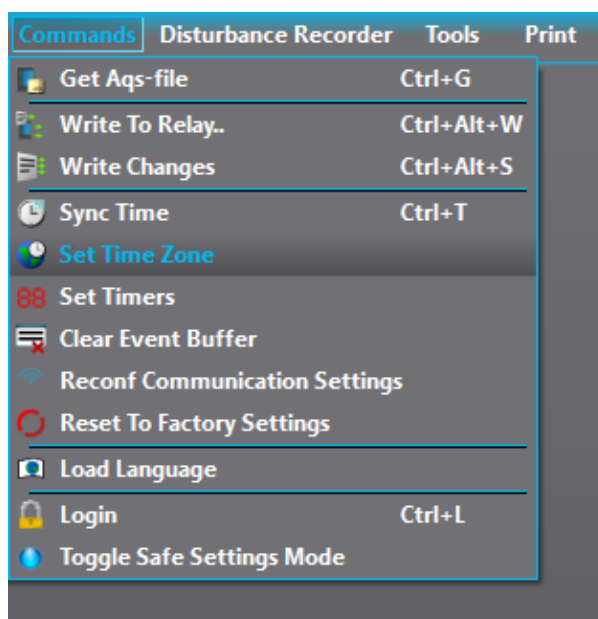

The desired time zone can be selected from the following dialog (see the image below).

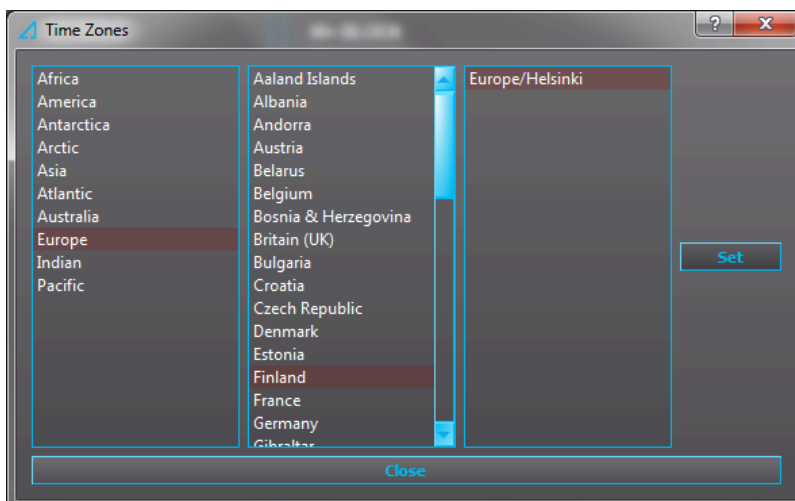

Synchronizing time

If there is no time synchronization source you can synchronize the relay time with the PC time: click *Commands* in the toolbar, and then select "Sync time" from the drop-down menu (see the image below).

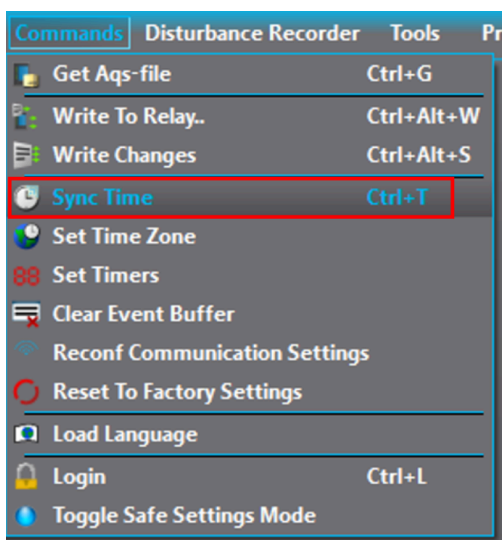

Alternatively, you can choose to synchronise the relay and PC times when you upload configurations to the relay by checking the box titled "Sync time" (see the image below).

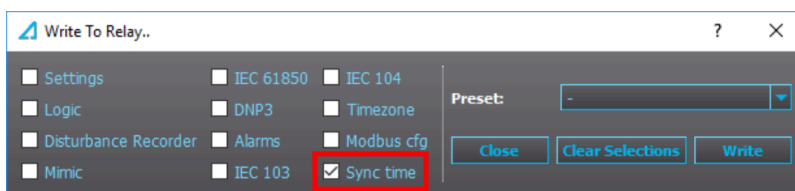

6.2 Uploading language files

For the time being, the AQ-200 series devices have five officially included languages: English, Finnish, French, Russian and Spanish. However, a customized language file can be uploaded to the relay. First, click *Commands* on the toolbar and select "Load language" from the drop-down menu (see the image below). This opens a file dialog which allows you to upload the desired language file to the relay.

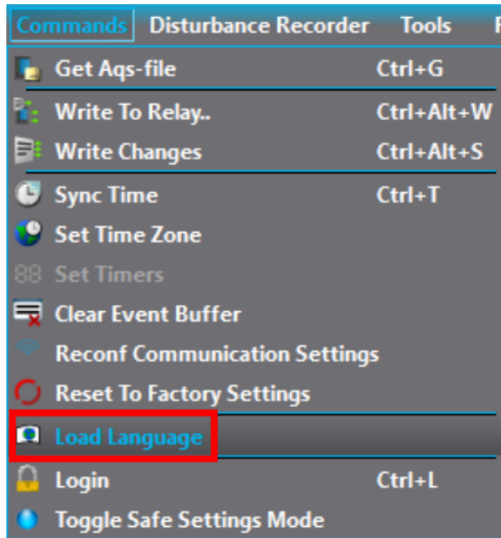

6.3 Set timers

You can set timer signals to help control setting groups and other logic components which activate and deactivate at certain intervals. First, click *Commands* in the toolbar and then select "Set timers" from the drop-down menu. When you click the green plus icon (+) at the top right of the window, you add a new timer configuration line. You can then select one of the displayed timers, and set its state to switch to 1 or 0 at a specific time.

The calendar view below the timer configuration line shows when a specific timer is on. Each timer has its own color code; the code is displayed at the top of the window above the timer configuration line. As can be seen in the example below, the state of the selected timer is 1 (as in, the timer is on) when a day's box is red. The red circle marks the current day (in this example, the date is November 13th). You can click on a day to see a more detailed division of the day below the calendar at the bottom of the window. Once the timers have been configured, you can send the configurations to the relay by clicking the "Set" button on the top right of the window. This requires an active connection to the relay.

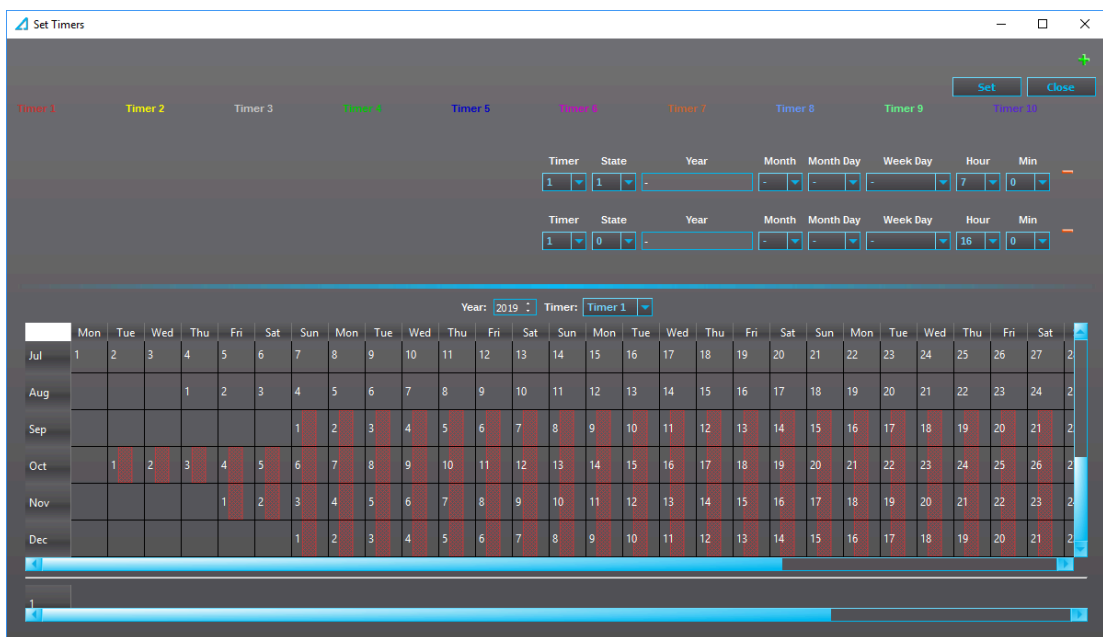

6.4 User levels and their passwords

There are four (4) user levels:

- Super user = has full accesss, including configurations
- Configurator = has access to all settings
- Operator = has access to limited settings and control
- User = can only view.

Each user level is represented by a specific lock icon in the HMI (see the image below).

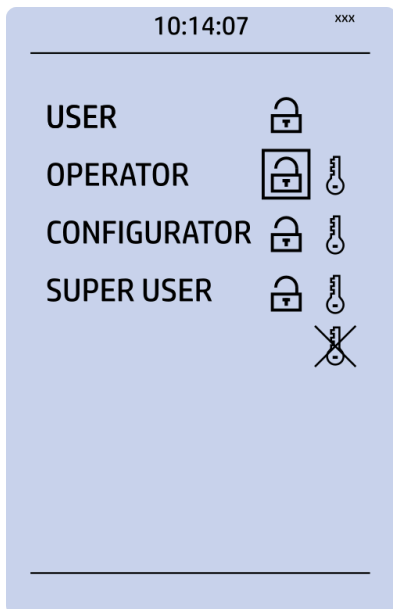

Setting up user levels in your local HMI

The factory default is that all user levels are unlocked in the device. You can activate and lock various user levels: push the **Lock** button in the device's HMI, choose the key icon for the user level, and then set the desired passwords for the different user levels (see the image below).



NOTE!

Passwords can only be set at the local HMI.

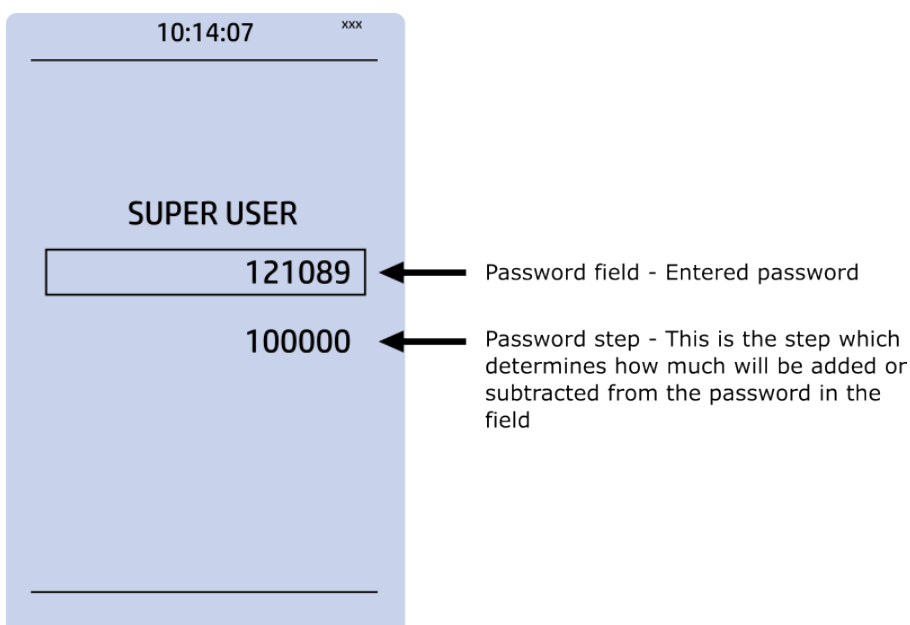

The key icon next to the user level allows you to set a new password for that user level. Any user level with a password can be locked by pressing the **Enter** key while the lock is selected. If you need to change the password, select the key icon again and give the new password. If you want to disable the password requirement for a specific user level, set the password to "0".

Please note that in AQ-x25x units the unlocking and locking of a user level generates a time-stamped event to the event log.

NOTE!



A user level with a password automatically locks itself after half an hour (30 minutes) of inactivity.

NOTE!



Changing the password requires that the user level in question is unlocked.

Accessing user levels in AQtivate

After you have activated the passwords, AQtivate requires your login information. Click *Commands* on the toolbar and select "Login" from the drop-down menu (see the image below).

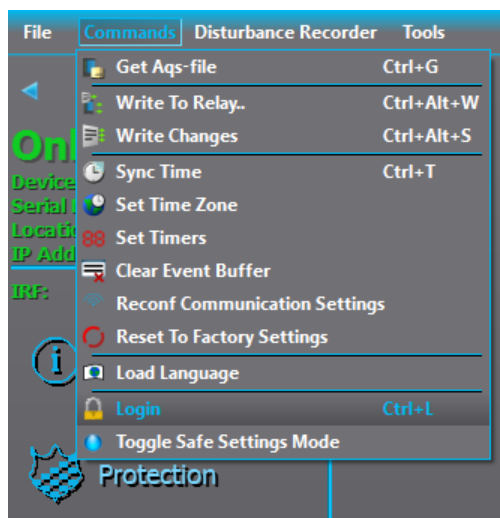

This makes The *Access levels* pop-up window appear (see the image below). Each level requires its own password to open it. When a user level is opened, an event is recorded to the relay's event history.

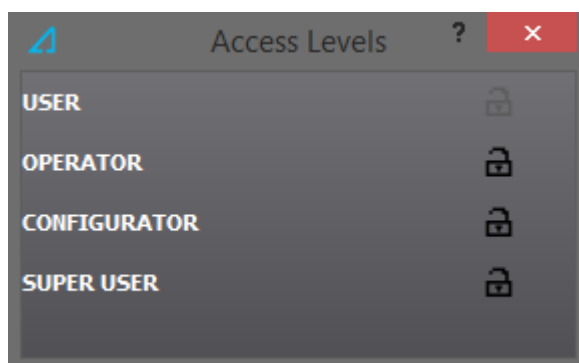

At the top of the AQtivate window, next to the Live Edit mode box, there are a number of yellow stars (see the image below). They indicate the active user level. Three yellow stars represent the Super user level, two yellow stars represent the Configurator level, and one yellow star represents the Operator level. If all stars are grey, the active level is User.

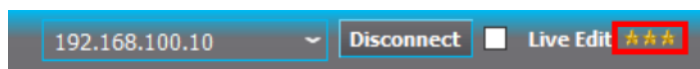

6.5 Clearing Event buffer

You can clear the event history by clicking *Commands* on the toolbar and selecting "Clear Event buffer". This clears the event history and places an "Event buffer clear" marker into the event history.

6.6 Reconfiguring communication settings

When you upload new communication IP settings to the relay, a prompt appears asking whether these settings will be adopted to use immediately (see the image below).

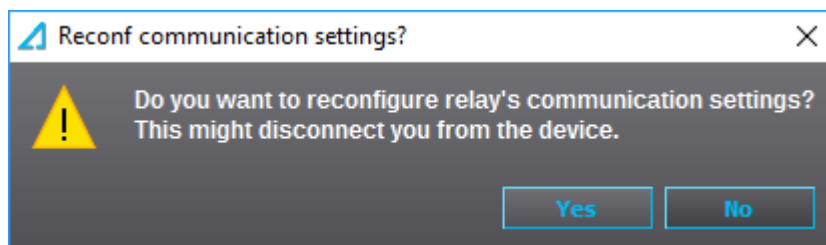

If "Yes" is selected, the new settings are adopted right away. If "No" is selected, the new IP settings will be adopted only after you have brought up the same window through AQtivate (*Commands* → *Reconf communication settings*) and clicked "Yes". If unit is rebooted before reconfiguration is done, unit will revert back to original IP address.

6.7 Safe Settings mode

You can toggle the Safe Settings mode: connect to a relay, click *Commands* on the AQtivate main toolbar, and select "Toggle Safe Settings mode" from the drop-down menu (see the image below).

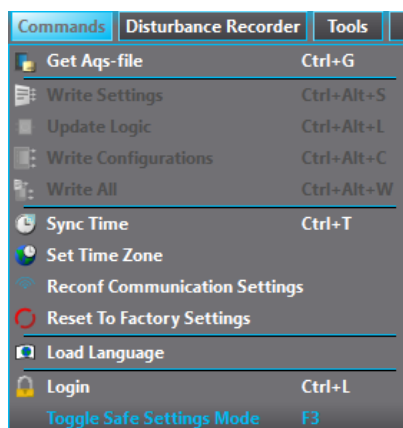

When in this mode, you can perform tests without causing the relay to actually control any of the output contacts. Events are still triggered normally.

Turning the Safe Settings mode on causes the relay to give a backup .aqs file. This backup has the current relay settings. If the new settings fail the test and you need the old setting back, you can use this backup .aqs file to retrieve them. The file also includes the event history dialog. This dialog can be used to see whether or not the test was successful.

When the Safe Settings mode is activated, a red SAFE MODE label appears on the main toolbar (see the image below).



When this mode is active, the HMI display of the device displays a skull at the top of the display and of the IRF output contact; the device's ERROR LED is activated.

You can disable the Safe Settings mode by clicking *Commands* → *Toggle Safe Settings mode* again.

7 Tools menu

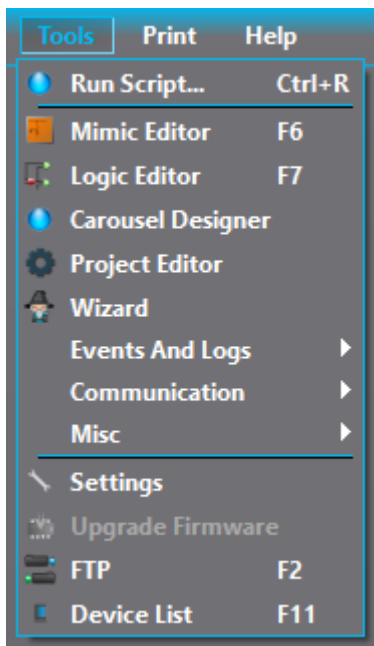

7.1 Running scripts

Occasionally Arcteq scripts need to be run to the relays. For example, you may need to run a script when you have changed the hardware configurations after installing a new card. You can do this by clicking *Tools* on the AQtivate main toolbar and selecting "Run script" from the drop-down menu.

Disabling the firewall is recommended when running a script because the firewall may cause the script to fail. All scripts are provided by Arcteq personnel.

7.2 Mimic editor (AQ-210 series)

The Mimic editor is used to create a visualization of the protected system for the HMI. In this chapter we are going to take a look at the simple tools AQtivate has for making a mimic display for AQ-210 series units.

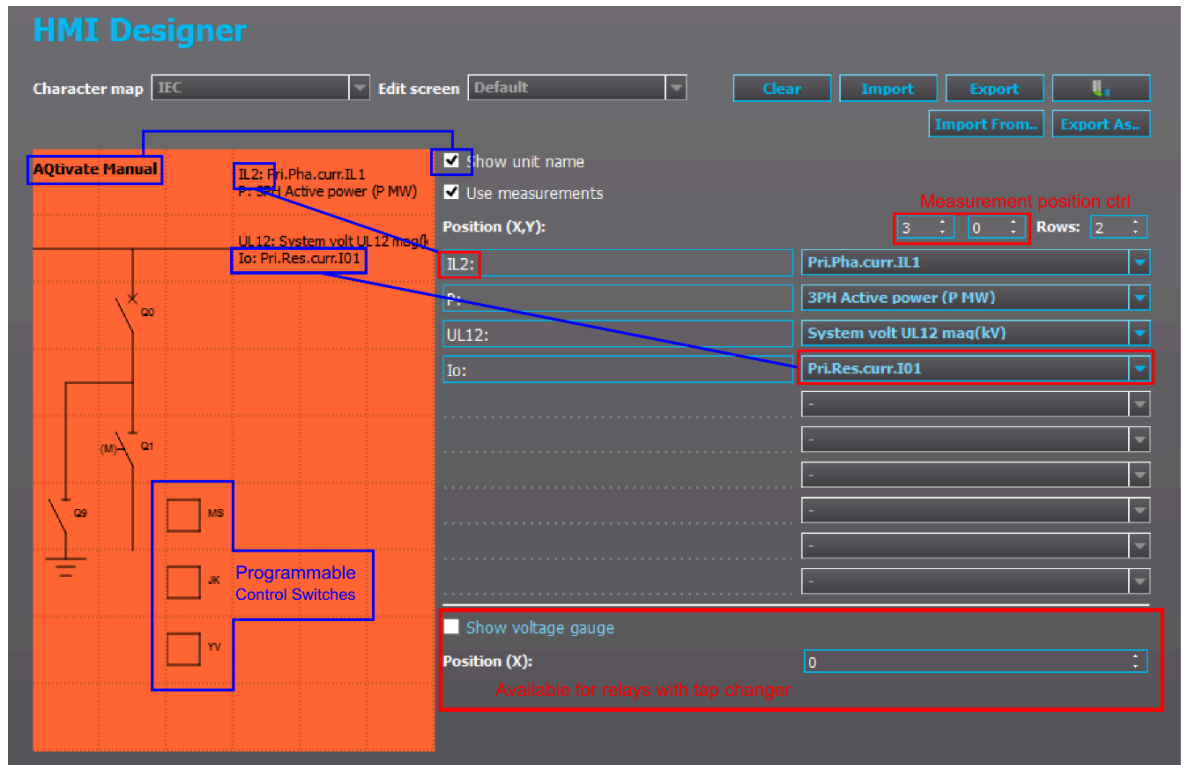

The mimic display is a 9x6 grid which can be edited individually. The selectable items in the Mimic editors' library include:

- Lines and icons for drawing purposes
- Objects and indicators to visualize the state of breakers and disconnectors (configured in the *Objects* tab of the *Control* menu).
- Programmable control switches which can control logic, setting groups, etc.

The grid can be cleared by clicking the "Clear" button.

Adding symbols and objects

Click on one of the boxes in the grid and an *Object menu* appears. Select the item you want to use from the "Select item" drop-down menu. The frame on the right shows what the item looks like.

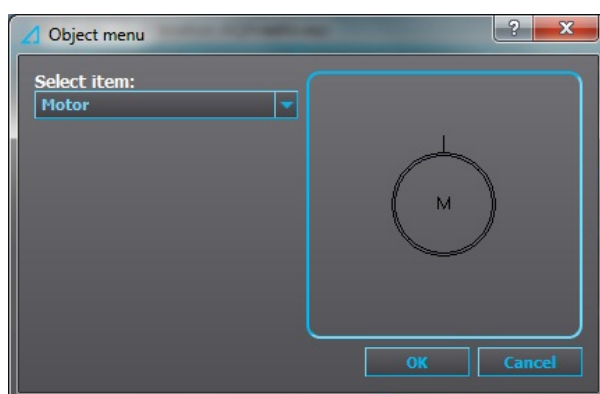

Adding measurements

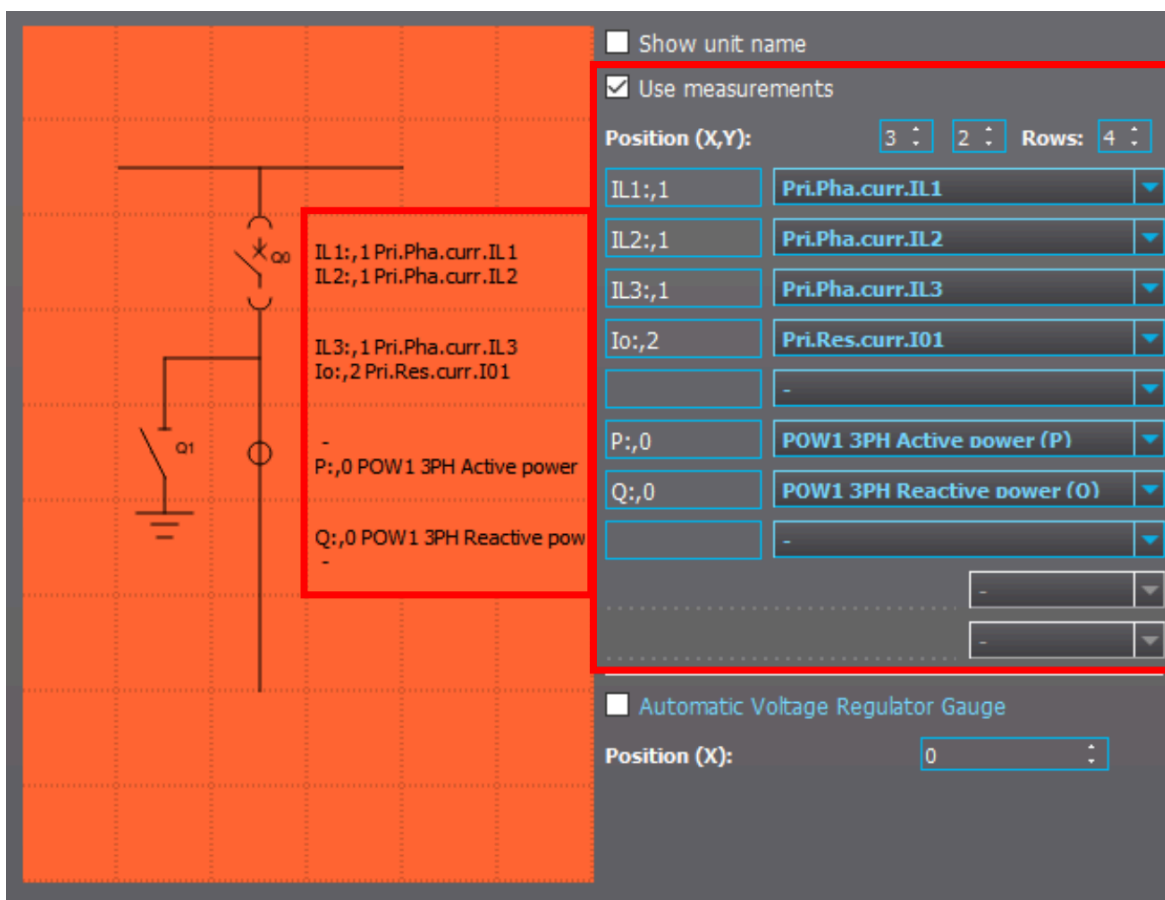

You can add measurements into the mimic by using the drop-down menus on the right side of the HMI designer (see the image above). The HMI display can use up to ten (10) different measurements. The text boxes are used to describe what the measurements represent. If you put a comma after the text, you can define the precision of the measurement by customizing how many decimal places are used for the value. For example, "I01:,2" gives the primary residual current with the accuracy of two decimal places.

You can change which measurement is given in which row by selecting the measurement from the drop-down boxes to the right of the "Position (X,Y)" text. Changing the number of rows also changes how many measurements can be shown in the mimic. However, each row can only fit two measurements.

Adding programmable mimic indicators

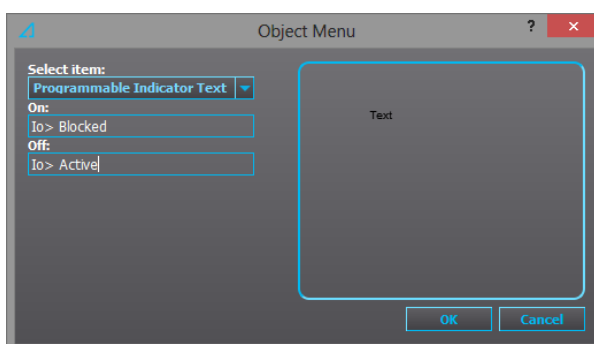
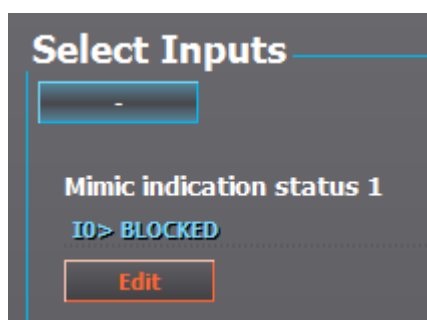

Programmable mimic indicators can display texts which indicate the status of the network. In the example image above, the I0> BLOCKED signal has been assigned to the Mimic indication status 1 (through *Control* → *Device I/O* → *Programmable mimic indication*). Then you can choose a box from the Mimic editor grid and select "Programmable indicator text" from the library. Before clicking "OK" type in the texts you want displayed on the screen when the signal is on and when it is off.

Loading the mimic to relay



If you have an active connection to a relay, click the "Send to relay" button (highlighted in the image above) to send the mimic into the relay.

Exporting the mimic

After you are finished creating the mimic, clicking the "Export" button makes it a part of the .aqs configuration file you are working on. Please note that the export command is executed automatically after certain functions, while it is not executed automatically after other functions (such as editing the measurements text field).

Saving the mimic as a separate file

The mimic can be saved as a separate file by clicking the "Export As.." button. You can import a mimic from these separate files by pressing the "Import from.." button. This is a useful tool especially when there are several relays with similar custom mimics. You can also use the Export and Import buttons to copy the same mimic to other .aqs files.

7.3 Mimic editor (AQ-250 series)

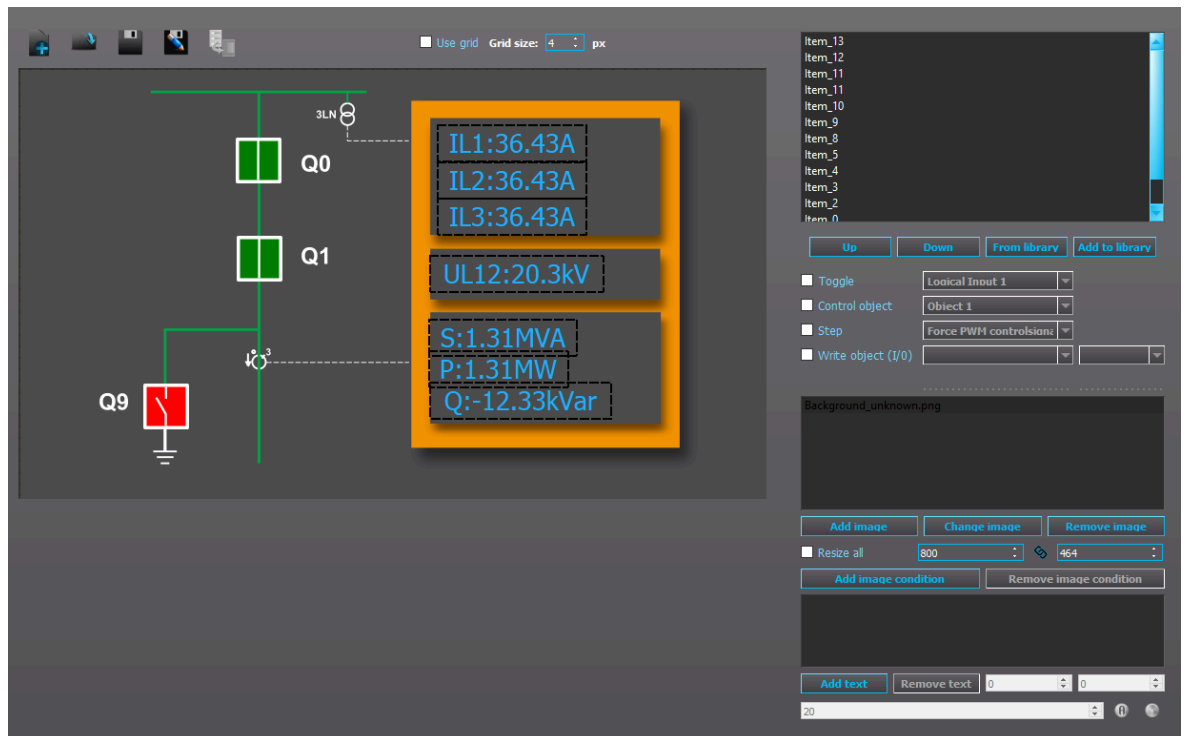

The Mimic editor is used to create a visualization of the protected system for the HMI. In this chapter we are going to take a look at the tools AQtivate has for making a mimic display for AQ-250 series units. AQ-250 series devices can store up to five (5) mimics.

The image and table below present the functions available to you in the Mimic editor's main toolbar.

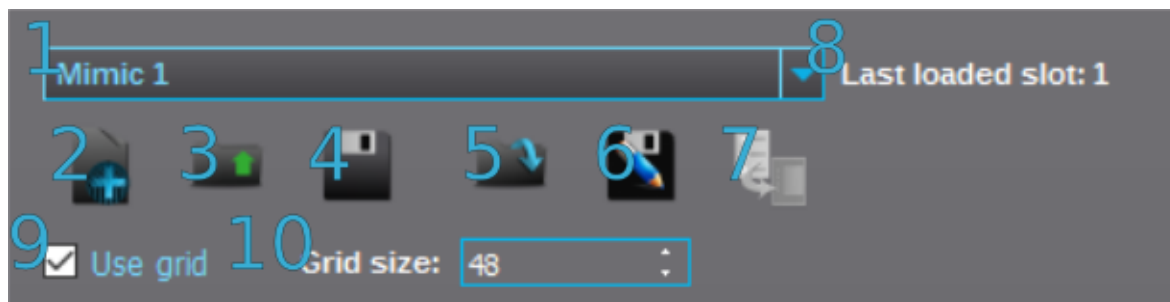

(#) Button	Description
1. Mimic drop-down menu	Chooses which of the five available mimics is being worked on.
2. New	Empties the mimic sheet.
3. Reload	Reloads a previously saved version from the mimic slot chosen with the drop-down menu (#1).
4. Save	Saves the mimic to the currently open .aq5 file and to the mimic slot chosen from the drop-down menu (#1).
5. Open	Opens a mimic file.
6. Save as...	Saves the mimic file as a separate file.
7. Send to relay	Sends the currently open mimic to the relay if there is a connection to the relay.
8. Last loaded slot	Indicates the slot to which the mimic has been loaded.
9. Use grid	If the grid is in use, items in the mimic editor move by the number of pixels defined in "Grid size" (#10).
10. Grid size	Defines the number of pixels that items move each step when "Use grid" (#9) is enabled.

Adding and removing items

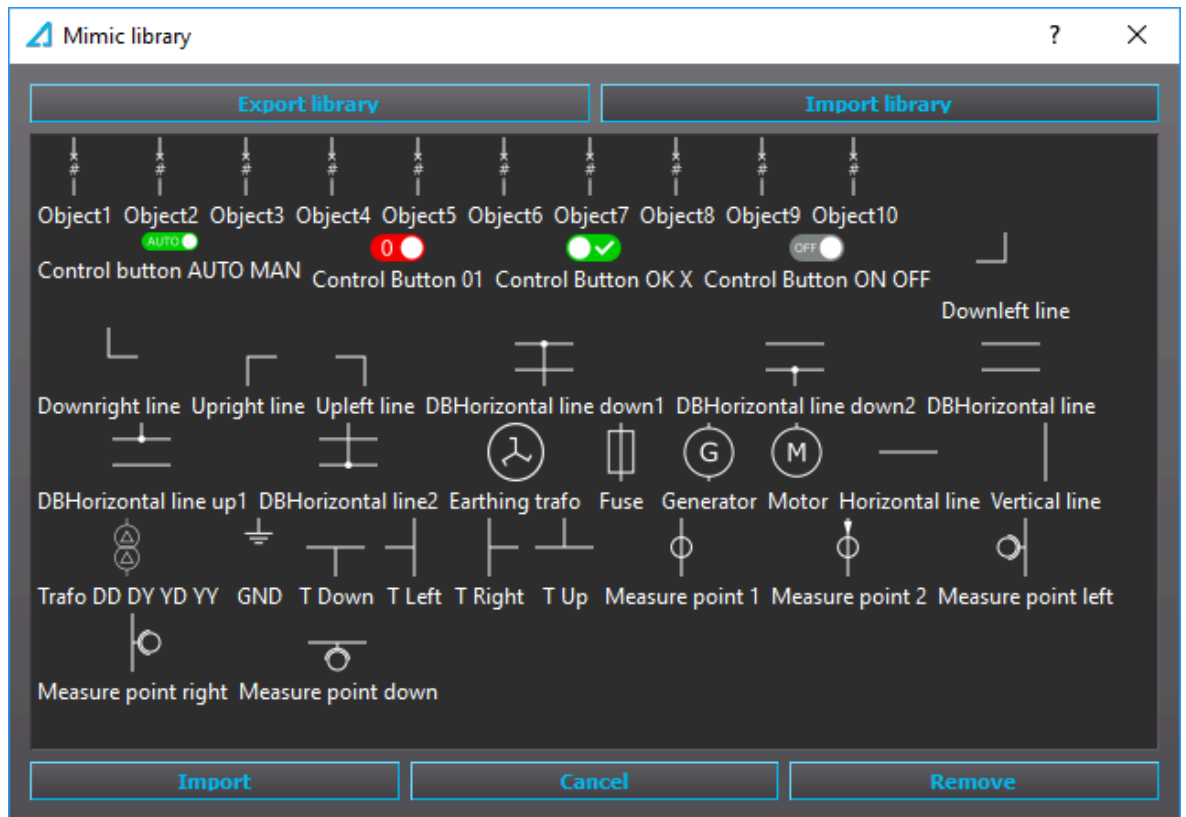

You can add items to the mimic by right-clicking somewhere on the mimic sheet and selecting "Add item" from the menu that appears. By clicking the "From library" button on the right, you get a pop-up window with the various item types that are already in the library. Select an item and then press the "Import" button. You can resize the items and move them on the mimic grid. You can also add a selected item to a library with the item name as its title with the "Add to library" button. An item that has been added to a library can then be used again by choosing it from the list by clicking "From library".

You can also remove items from the mimic: right-click on an item on the mimic and select "Remove item" from the menu that appears next to the cursor. Alternatively, you can select the to-be-deleted item from the list at the top-right window, right-click it and select "Delete" from the menu.

Item management

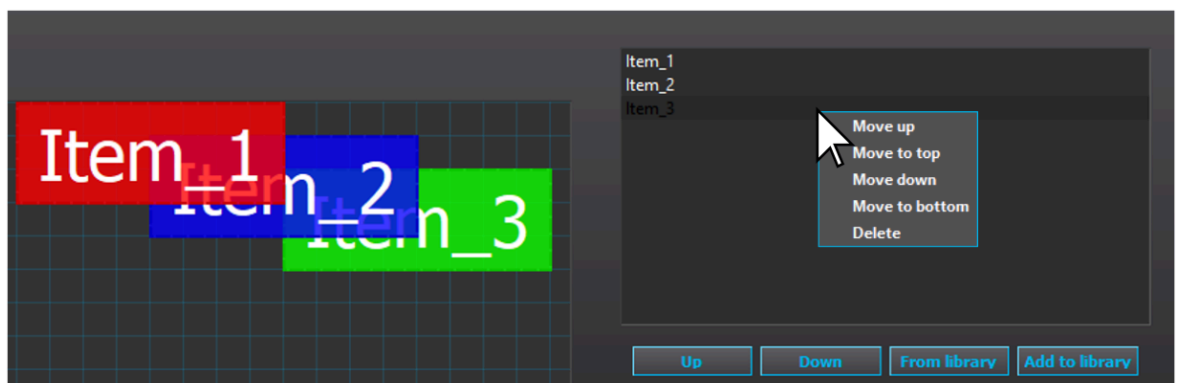

You can move an item to the front and back one step at a time with the "Up" and "Down" buttons. The item at the top of the list is in the front and the item in the bottom of the list is the furthest back. You can also rename the item by double-clicking it on the list. Right-clicking an item brings up more options for moving and deleting it.

Function control item

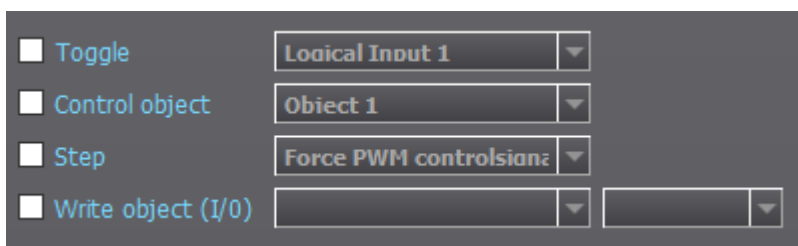

You can select between four (4) function controls; only one can be selected at any one time. "Toggle" allows you to control logical inputs ON (1) and OFF (0) with the selected item. "Control object" lists the available objects that can be controlled with the item. "Step" controls the functions related to Generator commander. "Write object (I/O)" controls objects such as the voltage regulator with up and down commands.

Item images and visibility conditions

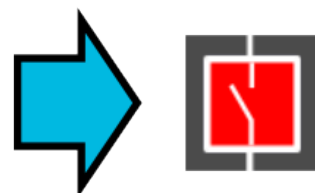
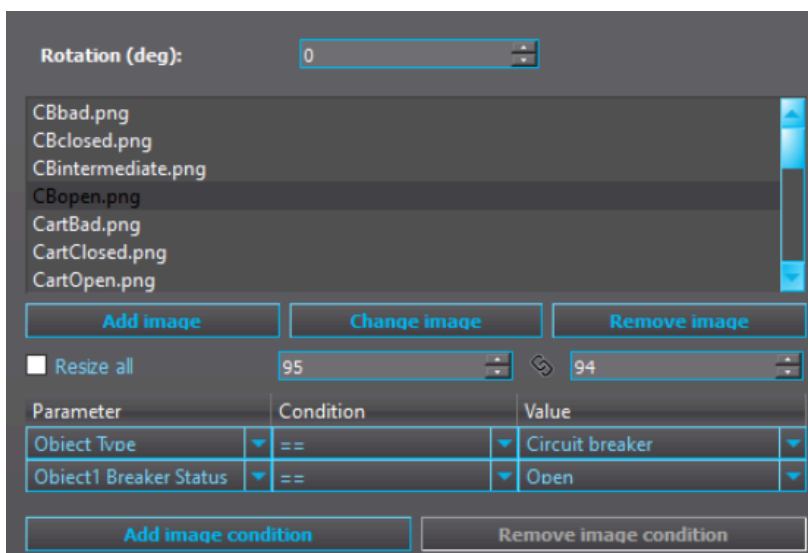

An item can contain one or more images. Each image can then be assigned with one or more visibility conditions with "Add image condition". If no visibility condition is assigned, the image is always displayed. If two images are visible in the same item at the same time, the image that is at the top of the list is displayed. If multiple visibility conditions are applied, all conditions must be met for the image to be displayed. In the example above, the image "CBopen.png" is visible if the parameter "Object type" is set to "Circuit breaker" and its status (as in the parameter "Object2 Break") is "Open".

The "Change image" button allows you to change the image while retaining the image conditions of the image being replaced. Please note that the new image is applied with the original resolution. You can resize it (and other images) by changing the resolution number located next to the "Resize all" button; if that button is active, you resize all the images in the item at the same time.

Rotation (deg) rotates the images in the item. Changing this setting rotates every image in the item.

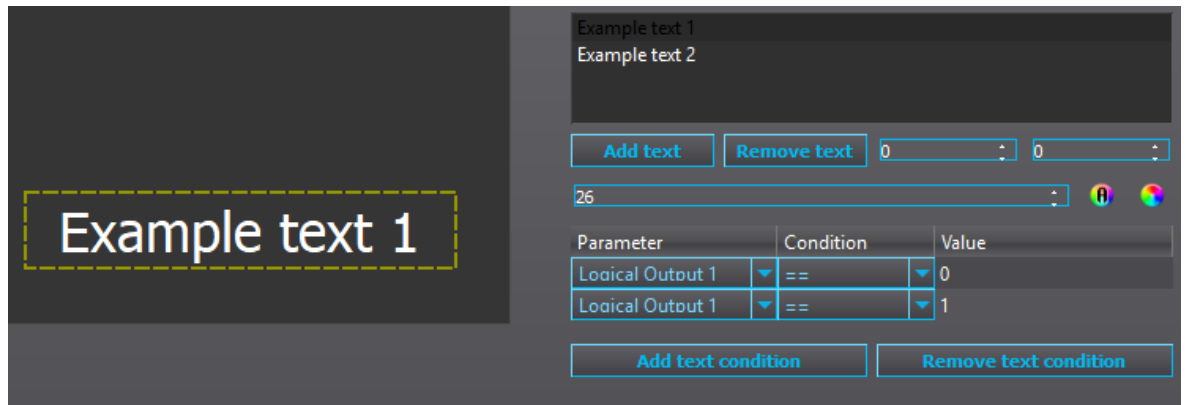

An item can contain one or more texts. Each text can then be assigned with one or more visibility conditions. If no visibility condition is assigned, the text is always displayed. If two texts are visible in the same item at the same time, the texts are displayed on top of each other unless the texts within the item have been moved by changing their text position numbers. If multiple visibility conditions are applied, all conditions must be met for the text to be displayed.

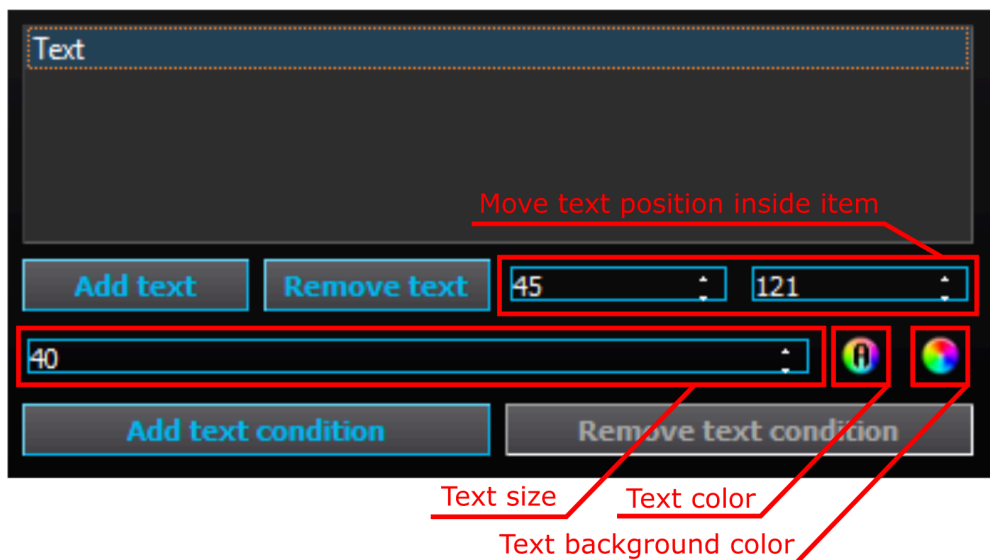

The image above presents the various text settings available in the Mimic editor. The default font size for texts added to items is 12; however, you can resize the font with the number box. You can also move the text's position inside the item with the two number boxes (the left one moves the texts horizontally, the right one vertically). Additionally, you can add and remove text conditions with their respective buttons. You can also change the color of the text (the multicolored circle with A) and the color of the text's background (the multicolored circle).

There are a total of six ways to pick a color for text or its background (see the image below):

- A) From the collection of basic colors
- B) From the color gradient grid and brightness slider
- C) Move the cursor to any point on the screen and click to use that specific color
- D) From the collection of saved custom colors
- E) Edit the red, green and blue integers as well as the hue, saturation and brightness individually
- F) Enter the color's HTML code

In addition to these settings, the "Alpha channel" number box sets the transparency of the text or of the text background (0 = fully transparent, 255 = fully visible).

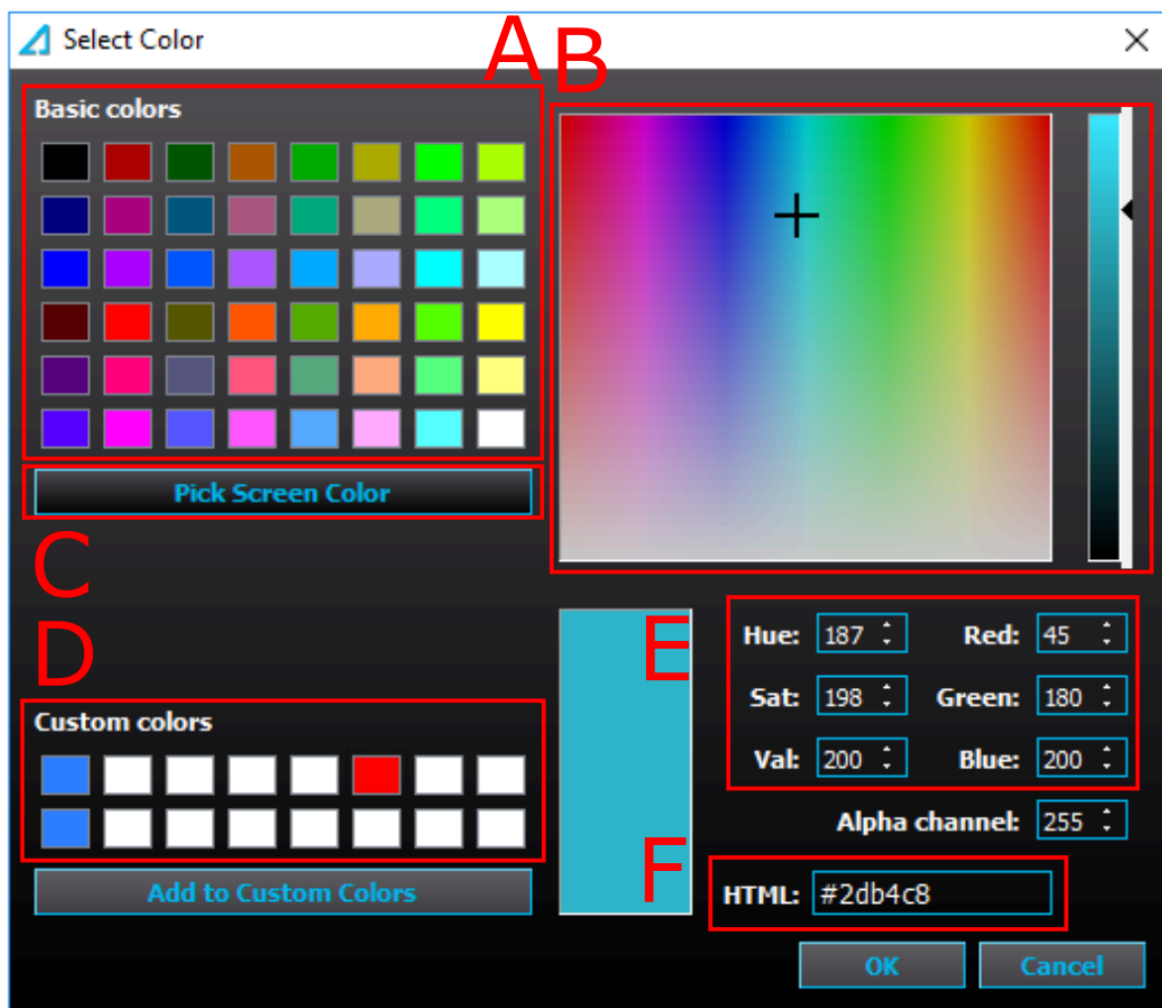

The same item can be applied with both images and texts. For example, you can have the component's abbreviation (e.g. "Q0") next to the image (see the image below).

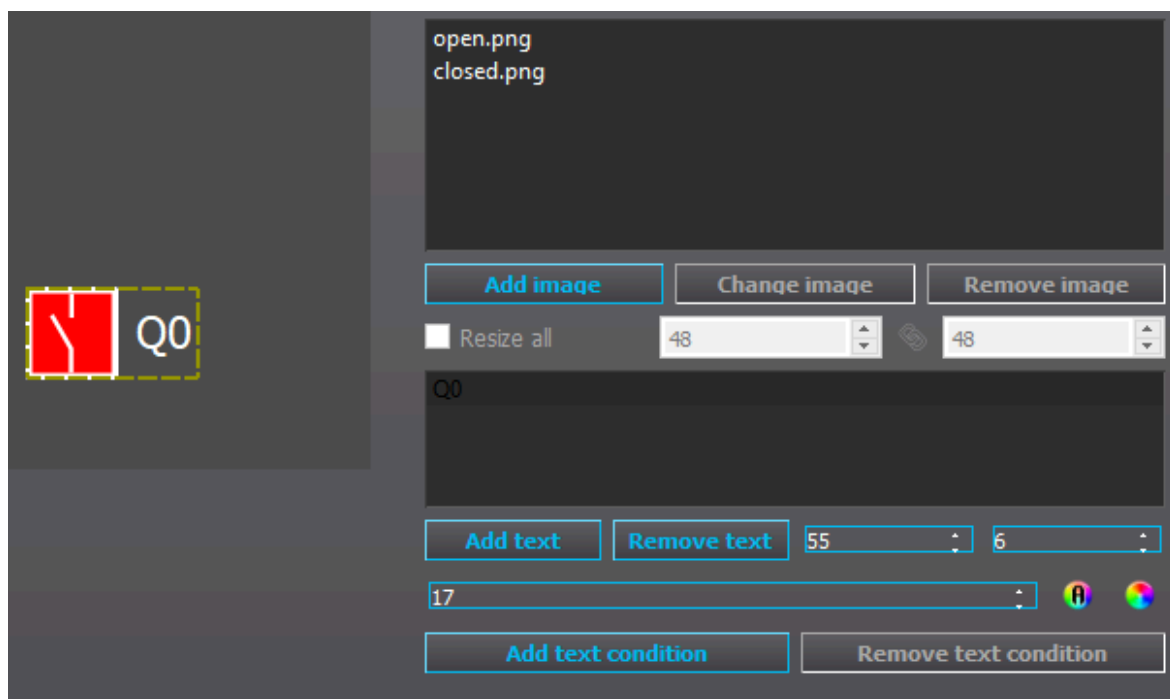

Adding measurements to the mimic view

You can add measurements by right-clicking the mimic sheet and selecting "Add measurements" from the menu that appears. The following setting selection (see image below) appears on the right side of the Mimic editor window.

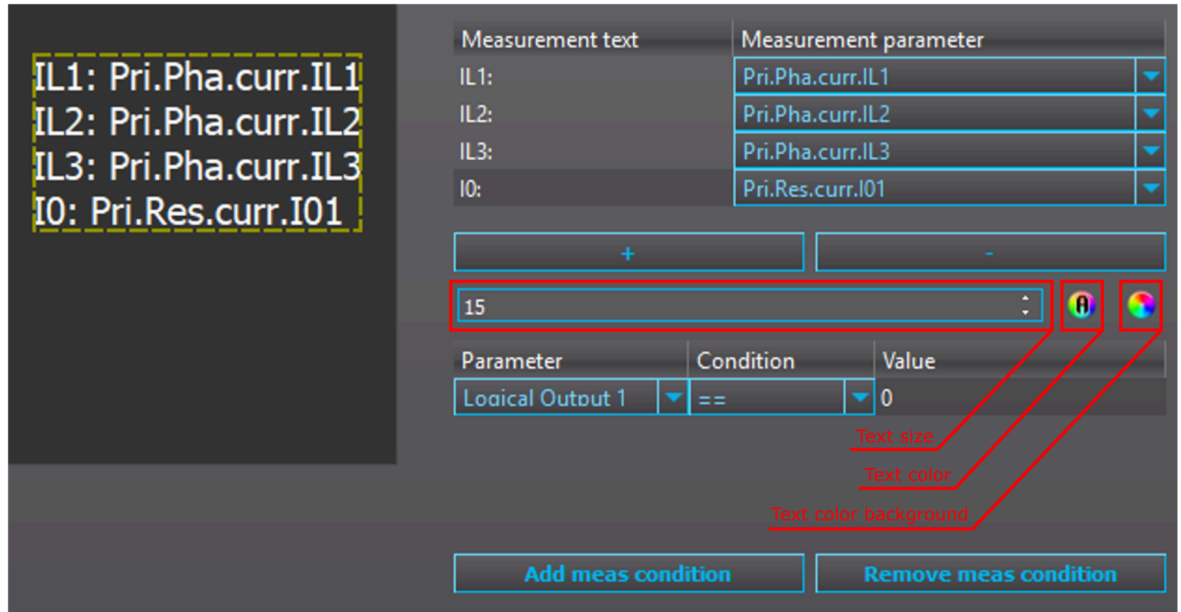

The plus (+) button adds a new row to the measurement item. You can add a prefix to any measurement row by right-clicking its slot below "Measurement text". From the "Measurement parameter" drop-down menus you can define which measurement is shown in the mimic. Additionally, you can change the font size, the text color, and the text's background color in the same way as in text settings. *Measurement text* is a user defined prefix for the measurement.

The measurement can be assigned with one or more visibility conditions. If no visibility condition is assigned, the measurement is always displayed. If multiple visibility conditions are applied, all conditions must be met for the measurement to be displayed.

Adding measurement bar to mimic view

You can add measurements bars by right-clicking the mimic sheet and selecting "Add measurement bar" from the menu that appears. The following setting selection (see image below) appears on the right side of the Mimic editor window.

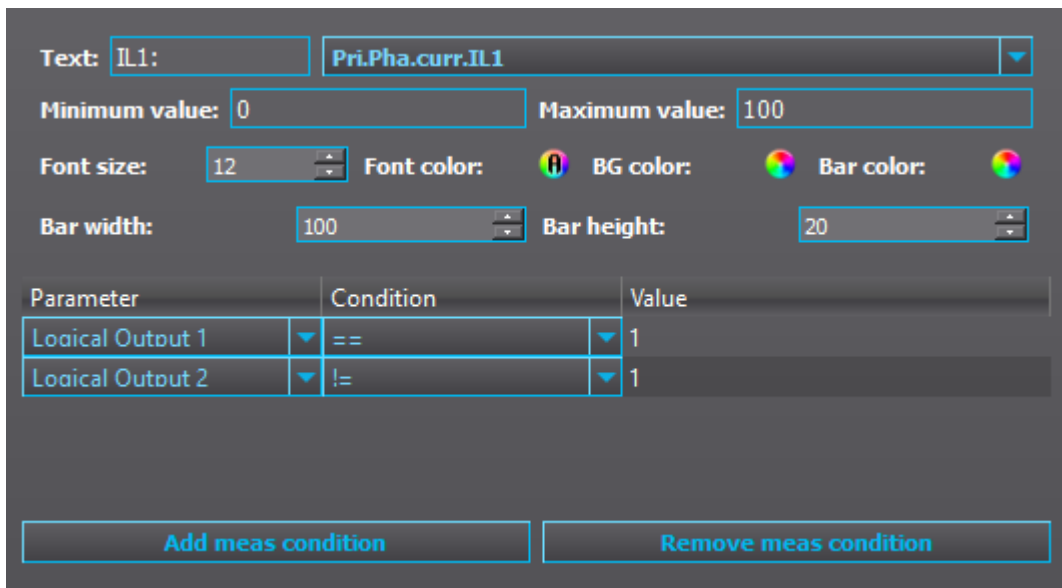

Setting	Description
Text	Defines the prefix shown before the measurement value.
Minimum value	Defines the lowest value bar can display. If measured value is lower than what is set here, the bar is displayed as empty. Doesn't affect how wide the bar appears in the mimic. Use "Bar width" setting to change the width.
Maximum value	Defines the highest value bar can display. If measured value is higher than what is set here, the bar displays the highest value set. Doesn't affect how wide the bar appears in the mimic. Use "Bar width" setting to change the width.
Font size	Defines the font size of user defined prefix text and measurement value text.
Font color	Changes the color of user defined prefix text and measurement value text. Uses the same tools as items in text (described previously).
BG color	Changes the color of text behind prefix text and measurement value text. Uses the same tools as items in text (described previously).
Bar color	Changes the color of measurement bar. Uses the same tools as items in text (described previously).
Bar width	Changes the width of the bar. Setting is in pixels.
Bar height	Changes the height of the bar. Setting is in pixels.

The settings shown in the image above with default color settings results in this bar below.

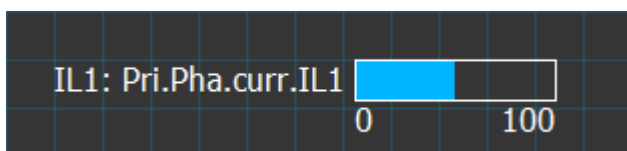

7.4 Logic editor

7.4.1 Logic editor (AQ-210 series)

Logic editor has the tools that are most commonly needed in logic programming.

The image below presents an example where the NOT and AND gates are ON (the wires are green), and the DI7 Q0 Open input is ON (the text is green). If The Live Edit mode is activated, you can observe the status of each signal in real time.

Figure. 7.4.1 - 17. Example with NOT and AND gates.

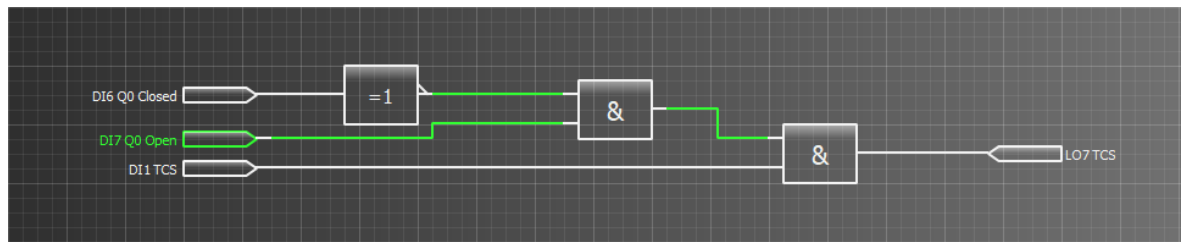

NOTE!



The logic is updated every 5 ms in the relay. Fast events might not be seen in Live Edit mode. For reliable event activation and de-activation analysis it is recommended to use event recording and disturbance recordings instead.

NOTE!



Logic must be designed from left to right. The logic gate operation that must be done first must be furthest to the left on the canvas. If the order is important, make sure one is not placed right below another.

NOTE!



While very large and complex logics can be made with the logic editor, the number of logic gates and wires that can be placed is limited. The maximum number of gates is 768, and for wires the maximum is 256. The number of wires currently used is displayed as a percentage value at *Monitoring* → "Device diagnostics" in the parameters "Gates usage" and "Wires usage". These parameters will update only after the logic has been loaded to the relay.

Logic editor command buttons

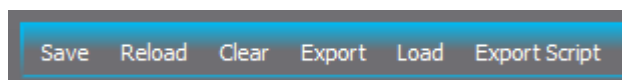

Logic editor has the following commands on its main toolbar:

- **Save**
Saves the logic to the .aq5 file that is currently open.
- **Reload**
Loads back the logic that is in use in the .aq5 file that is currently open.
- **Clear**
Clears the logic sheet.
- **Export**
Saves the logic as an .aq1 file that can then be opened in another .aq5 file. It also functions as backup save of the logic.
- **Load**
Opens any .aq1 logic file.
- **Export script**
Saves only the script of the logic. Mostly used by Arcteq personnel for troubleshooting purposes.

Adding and removing logic gates, inputs and outputs

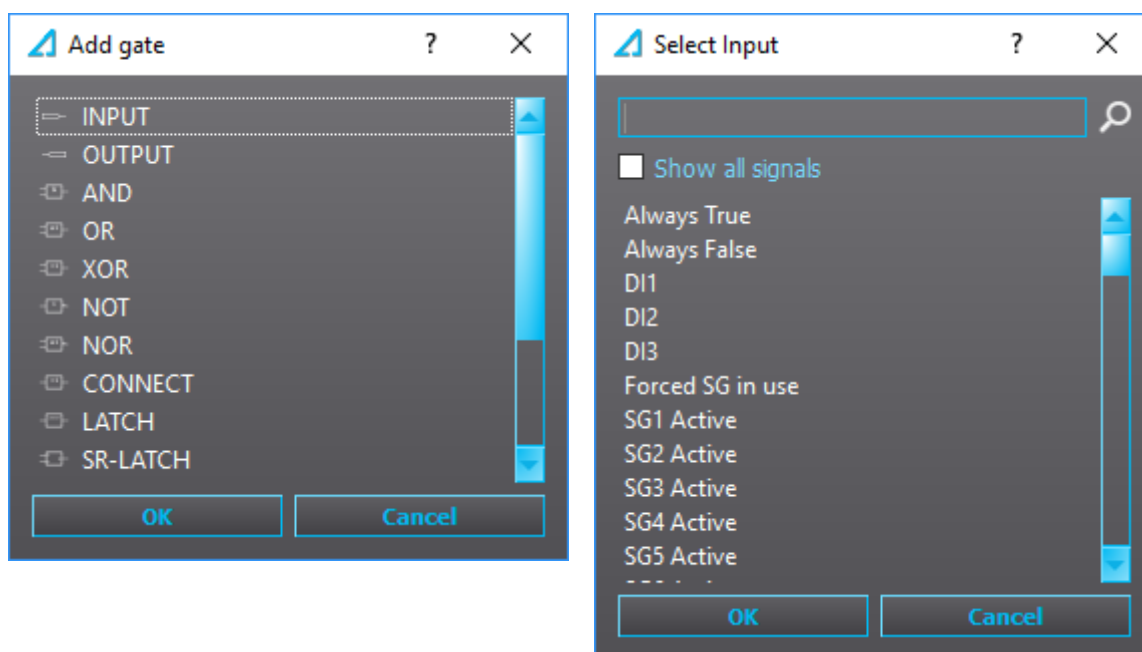

You can add a logic gate to the table by double-clicking on the table, selecting the wanted logic gate from the pop-up window (see the image above on the left), and then clicking the "OK" button. To choose the specific signal for your input and output gates, double-click the I/O symbol on the table and select the wanted signal from the pop-up window.

You can filter the signal with the search box. For example, typing "trip" to the search box lists all signals that contain the word 'trip'. The editor does not differentiate between upper and lower case, so "trip", "Trip" and "TRIP" all result in the same signal list (see the image below).

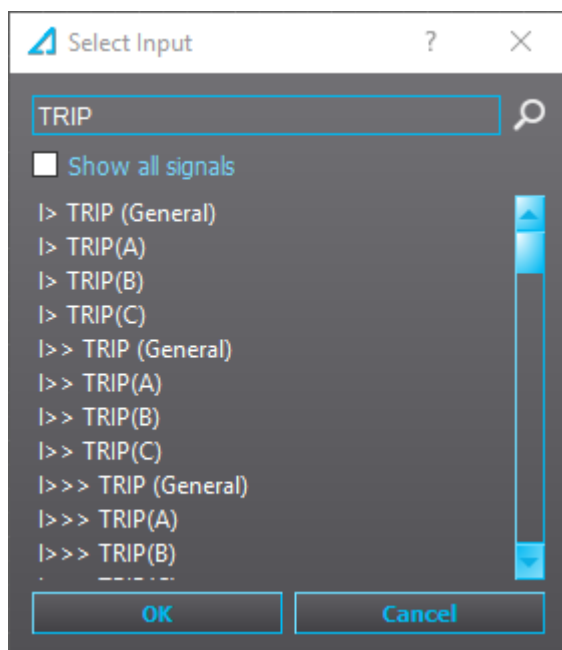

If you want to remove a gate or a wire, you can click it (making it red) and then press **Delete**. If there are multiple items on the logic sheet you want to delete simultaneously, paint the area with your mouse (making all components within that area red) and then press **Delete** (see the image below). Painted logic can also be moved around and copied (**Ctrl + C**) and pasted (**Ctrl + V**).

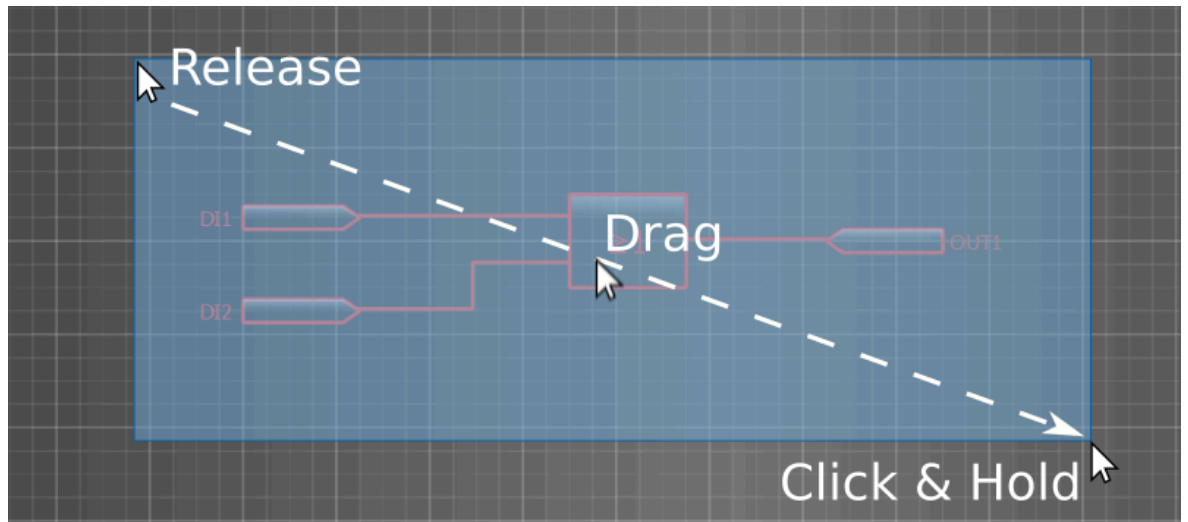

Drawing lines

When you hover the mouse over an input or output pin, a red box appears. Click the box, move the mouse to the destination and click on the box that appears (see the image below).

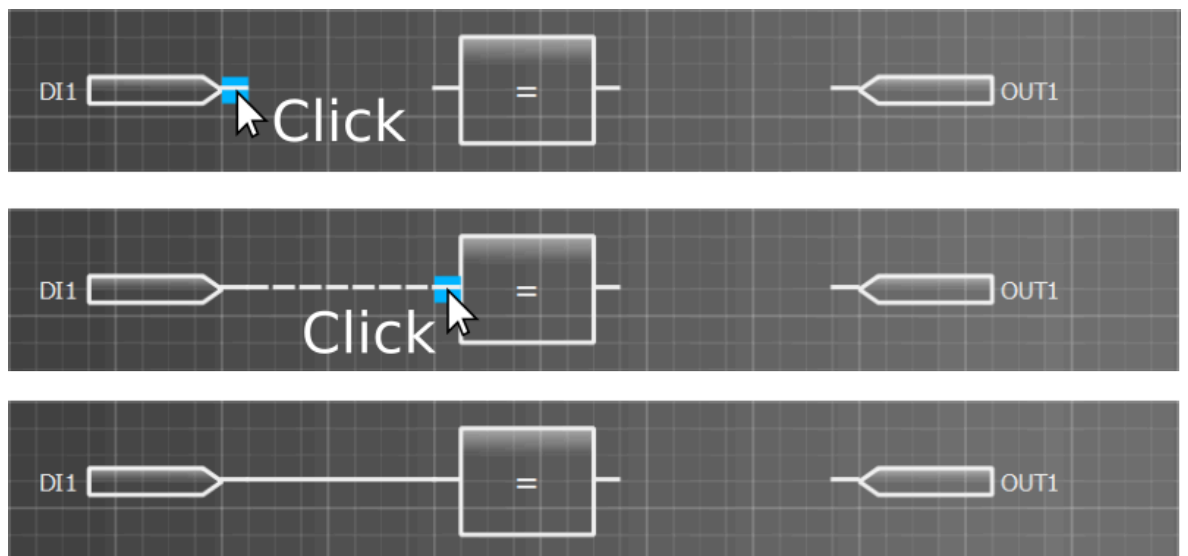

7.4.2 Logic editor (AQ-250 series)

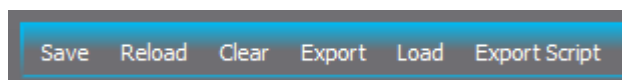

Logic editor has the tools that are most common for logic programming. Logic editor has the following commands on its main toolbar:

- **Save**
Saves the logic to the .aqs file that is currently open.
- **Reload**
Loads back the logic that is in use in the .aqs file that is currently open.
- **Clear**
Clears the logic sheet.
- **Export**
Saves the logic as an .aql file that can then be opened in another .aqs file. It also functions as backup save of the logic.

- **Load**
Opens any .aql logic file.
- **Export script**
Saves only the script of the logic. Mostly used by Arcteq personnel for troubleshooting purposes.

AQ-250 series logics can be divided into multiple logic sheets. To add a new sheet, click on the "Plus" button (see the image below) or press **Ctrl+T**. These logic sheets can be renamed by double-clicking on the name. You can remove a logic sheet by clicking on the red "X" button in the top right corner of the sheet name box; note that the red "X" only appears when the cursor is on top of it (see the image below).

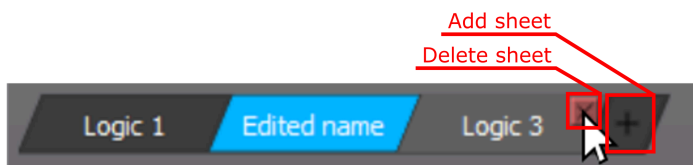

You can move the logic view with the directional keys (up, down, left, right). Alternatively, you can move vertically with the mouse scroll wheel, and horizontally by holding the **Alt** key while scrolling the mouse wheel. You can also zoom in and out by holding the **Ctrl** key while scrolling the mouse wheel.

NOTE!



The logic is updated every 5 ms in the relay. Fast events might not be seen in Live Edit mode. For reliable event activation and de-activation analysis it is recommended to use event recording and disturbance recordings instead.

NOTE!



Logic must be designed from left to right. The logic gate operation that must be done first must be furthest to the left on the canvas. If the order is important, make sure one is not placed right below another.

NOTE!



While very large and complex logics can be made with the logic editor, the number of logic gates and wires that can be used is limited. The maximum number of gates is 768, and for wires the maximum is 256. The number of wires currently used is displayed as a percentage value at *Monitoring* → "Device diagnostics" in the parameters "Gates usage" and "Wires usage". These parameters will update only after the logic has been loaded to the relay.

Adding inputs, outputs and logic gates

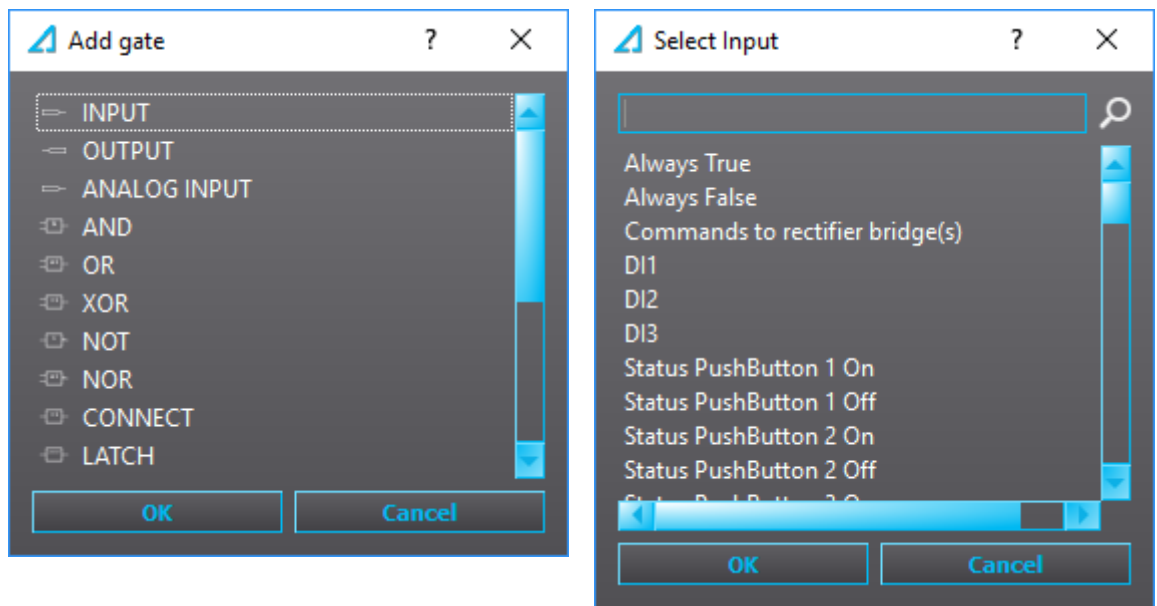

You can add a gate to the logic by double-clicking on the table, selecting the wanted gate from the pop-up window (see the image above on the left), and then clicking the "OK" button. To select the input or output signal, double-click an input or output on the logic sheet. Another pop-up window appears (see the image above on the right) and you can choose the signal from the list. You can filter the signal with the search box. For example, typing "trip" to the search box lists all signals that contain the word 'trip'. The editor does not differentiate between upper and lower case, so both "trip" and "TRIP" result in the same signal list (see the image below).

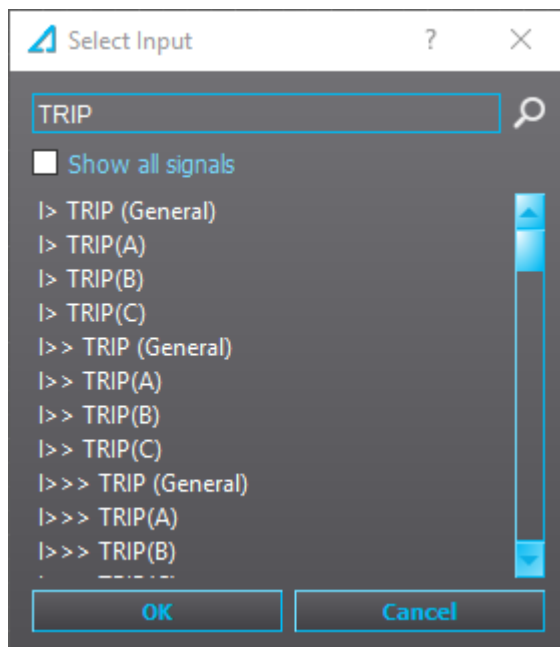

Multiple items in the logic sheet can be chosen to be edited simultaneously by painting the area with the mouse (see the image below). When multiple items have been painted, you can move the selected items, delete them (with the **Delete** key), or copy and paste them (with **Ctrl+C** and **Ctrl+V**, respectively).

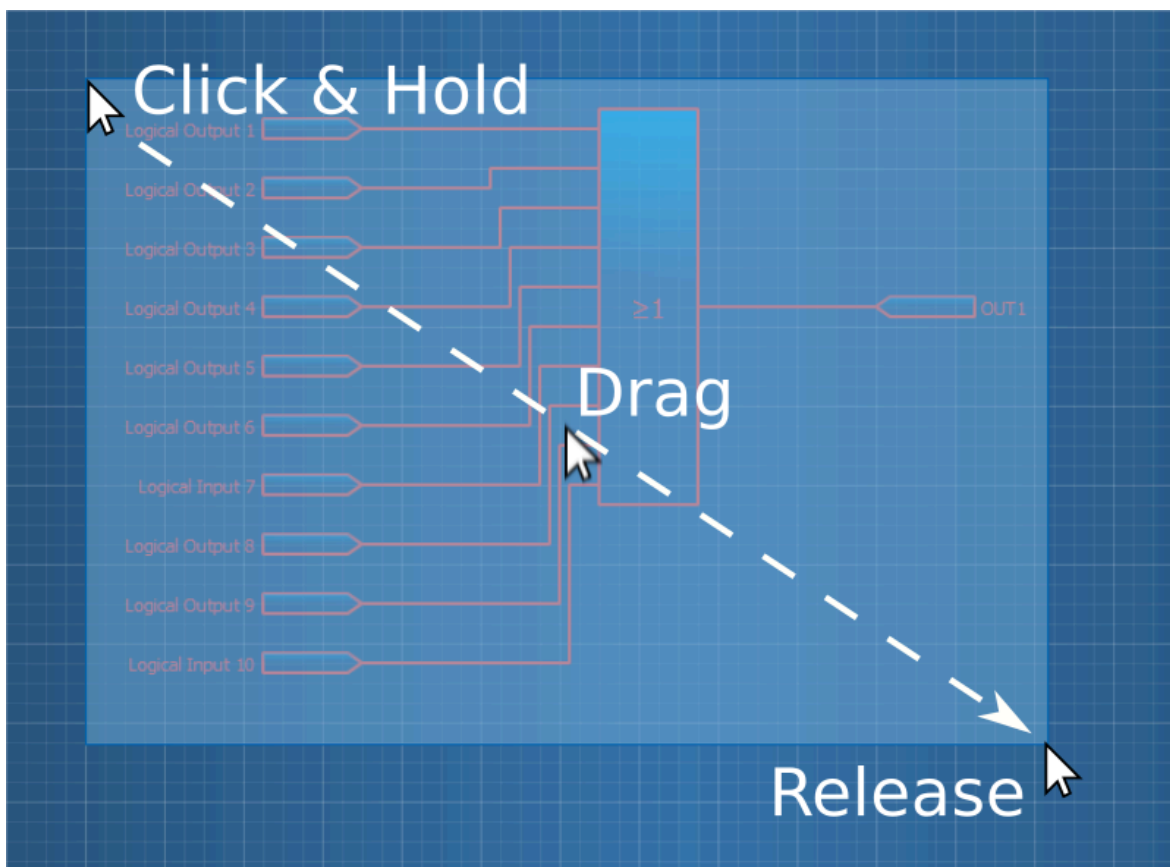

Drawing lines

When you hover the mouse over an input or output pin, a red box appears. Click the box, move the mouse to the destination and click on the box that appears (see the image sequence below).

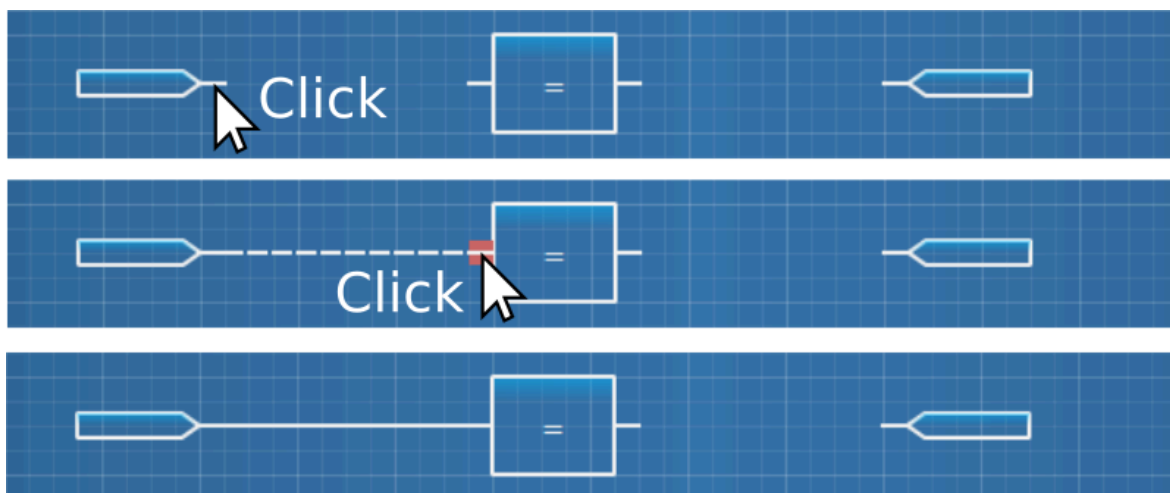

You can also connect signals to multiple destinations by repeating the previous steps (see the images below).

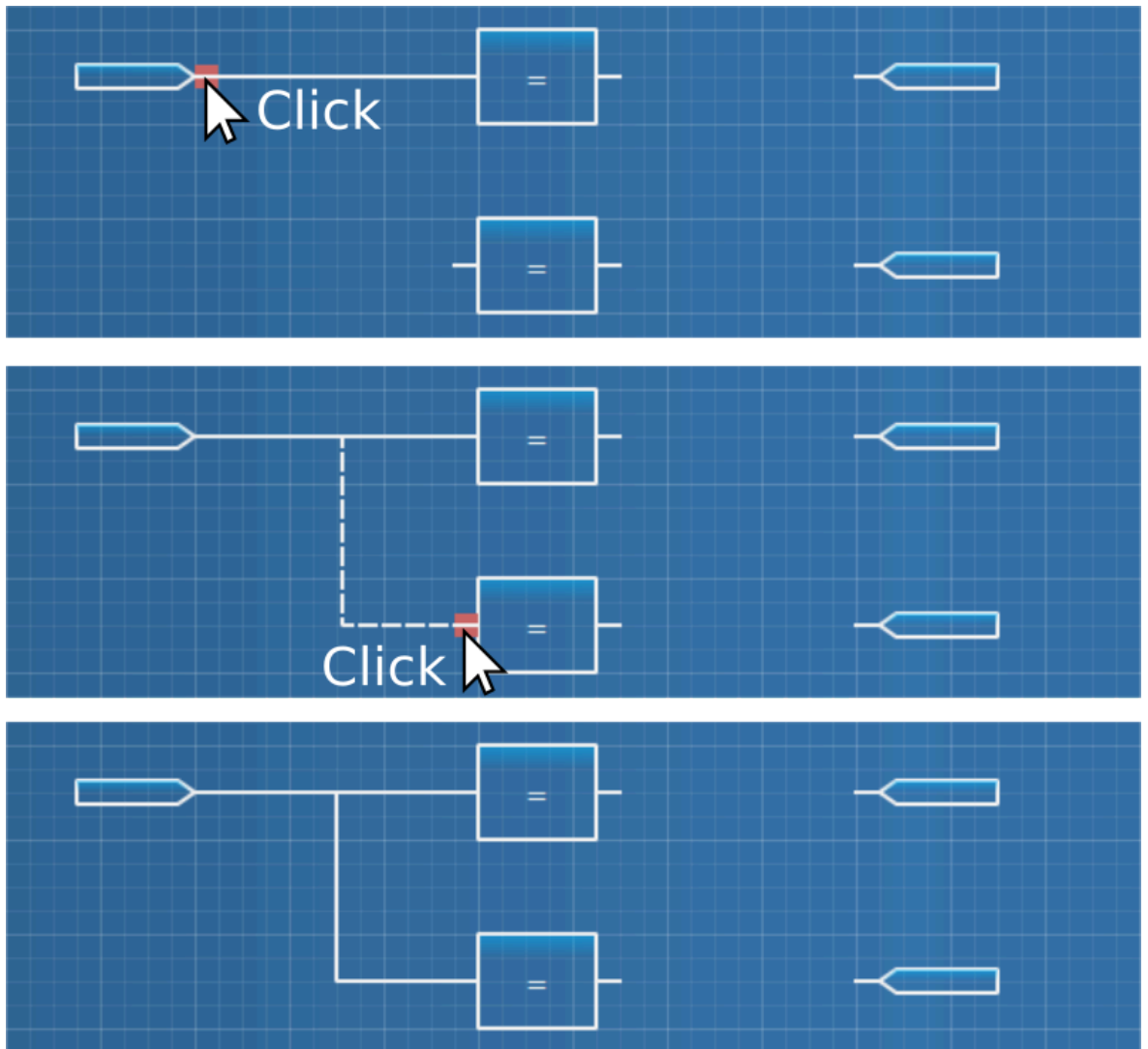

You can remove connections by clicking on the line and pressing the **Delete** key (see the images below). If you want to exit the wiring mode before connecting two pins, press **Esc**.

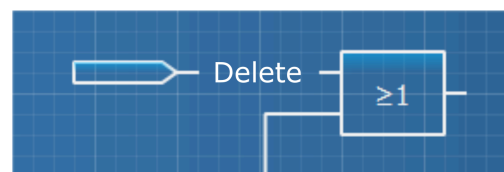
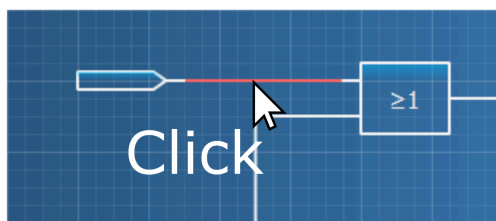

Some logic gates (such as OR gates) can take more than two inputs. This can be done by dragging a line close to the gate's inputs which makes more inputs appear (see the images below). You can add up to ten inputs to a single gate.

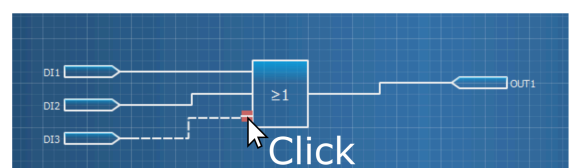
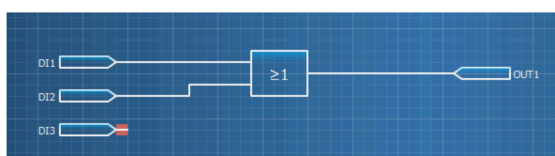

7.4.3 Logic gates

AQ-210 and AQ-250 devices mostly have the same logic gates. The available logic gates for each device type are listed in the table below.

Table. 7.4.3 - 3. Availability of logic gates in AQ-210 and AQ-250 devices

Gate name	AQ-210	AQ-250
INPUT	Yes	Yes
OUTPUT	Yes	Yes
CONNECT	Yes	Yes
NOT	Yes	Yes
AND	Yes	Yes
OR	Yes	Yes
XOR	Yes	Yes
NOR	Yes	Yes
SR latch	Yes	Yes
RS latch	-	Yes
D FLIP-FLOP	Yes	Yes
COUNTER	Yes	Yes
DELAY	Yes	Yes
EDGE	Yes	Yes
LATCH	Yes	Yes
ANALOG INPUT	-	Yes
ANALOG COMPARATOR	-	Yes

Input gate



Input gates are used for bringing user selected binary signals into the logic sheet. An input can be connected to multiple logic gates. It is possible to set multiple inputs with the same binary signal.

Output gate



Output gates are used for controlling digital outputs (output relays), high speed outputs, logical outputs, LEDs and Local/Remote switch. Outputs can also be used for resetting latched signals ("Reset latches") and silence alarm buzzers in alarm annunciator devices.

WARNING!



Because logic sheet configured in logic editor is the last part in a logic cycle, any output controlled here will dominate any other control signals elsewhere. This means a direct connection to an output contact in logic editor will result in connections to same output contact to be ignored elsewhere (e.g. matrix). If controlling the same output contact by multiple signals is desired, connect logical output to output gate and then connect the logical output in the matrix to an output contact.

CONNECT gate

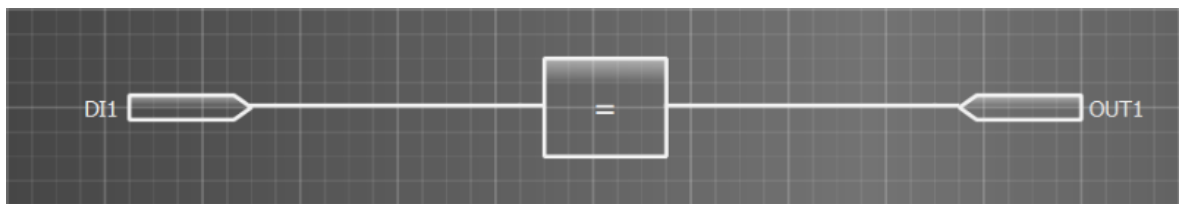

The Connect gate has two applications. The first, and the simplest, application is using the gate to connect a signal directly from an input to an output (as seen in the image above). The Connect gate is also used if an output of a logic gate needs to be connected to two outputs when configuring AQ-210 series devices. This is because AQ-210 series units do not support connecting the same signal to two outputs without a gate between them, and AQtivate does not let you make that kind of connections (see the image below on the left). In the image below on the right shows a correct way to connect two outputs to a logic gate.

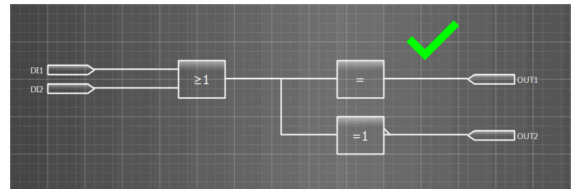
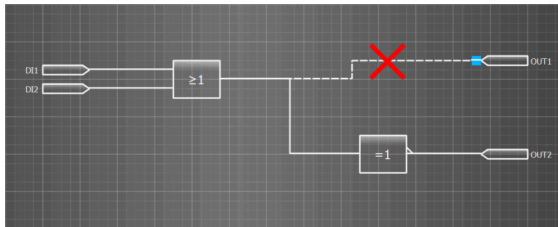

AQ-250 series units don't require a Connect gate when connecting to multiple outputs.

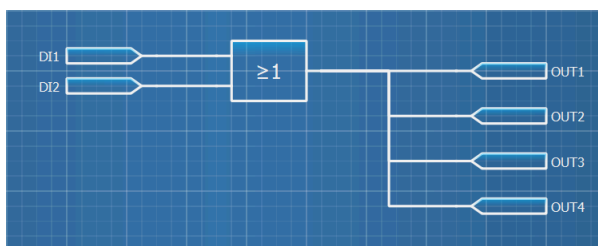

However, you can always connect a signal to a single output without a Connect gate (see the image below).

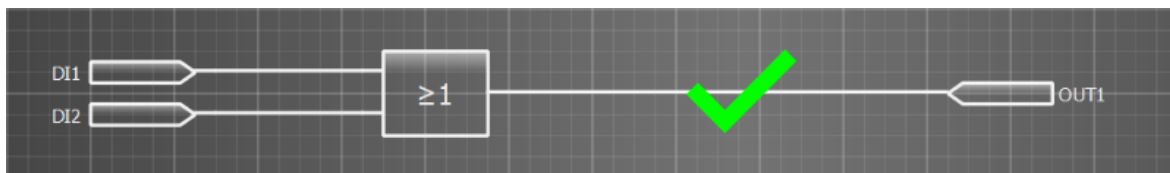
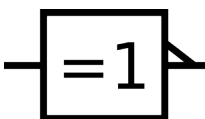

Figure. 7.4.3 - 18. The truth table of the CONNECT gate

Input	Output
0	0
1	1

NOT gate



NOT gate is a basic logic gate which inverts the input status.

Figure. 7.4.3 - 19. The truth table of the NOT gate

Input	Output
0	1
1	0

AND gate



AND gate is a basic logic gate which activates its output when all inputs are active.

Figure. 7.4.3 - 20. The truth table of the AND gate

Input 1	Input 2	Output
0	0	0
0	1	0
1	0	0
1	1	1

OR gate



OR gate is a basic logic gate which activates its output when at least one of the inputs are active.

Figure. 7.4.3 - 21. The truth table of the OR gate

Input 1	Input 2	Output
0	0	0
0	1	1
1	0	1
1	1	1

XOR gate

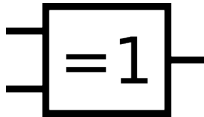

XOR gate is a basic logic gate which activates its output when only one of the inputs are active.

Figure. 7.4.3 - 22. The truth table of the XOR gate

Input 1	Input 2	Output
0	0	0
0	1	1
1	0	1
1	1	0

NOR gate



NOR gate is a basic logic gate which activates its output when none of the inputs are active.

Figure. 7.4.3 - 23. The truth table of the NOR gate

Input 1	Input 2	Output
0	0	1
0	1	0
1	0	0
1	1	0

SR-LATCH gate



The SR latch gate sets the output value to 1, when the S value is 1. The output value remains at 1 (even if the S value goes back to 0) until the R value is set to 1. If both S and R input are 1, the output value is set to 1.

Figure. 7.4.3 - 24. The truth table of the SR-LATCH gate

S	R	Output
0	0	Previous
0	1	0
1	0	1
1	1	1

RS-LATCH gate



The RS latch gate sets the output value to 1, when the S value is 1. The output value remains at 1 (even if the S value goes back to 0) until the R value is set to 1. If both S and R input are 1, the output value is set to 0.

Figure. 7.4.3 - 25. The truth table of the RS-LATCH gate

S	R	Output
0	0	Previous
0	1	0
1	0	1
1	1	0

D FLIP-FLOP gate



The D flip-flop gate captures the D input value every time the clock input ">" rises and then forwards the D input value to the output (Q).

Figure. 7.4.3 - 26. The truth table of the D FLIP-FLOP gate

>	D	Output
Rising	0	0
Rising	1	1
Non-rising	0	Previous

Counter gate

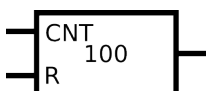

The Counter gate adds 1 to the counter value every time the value of the CNT signal goes to 1. When the counter value is equal to or higher than the trigger value, the output is set to 1. The R signal resets the counter to 0.

Delay gate

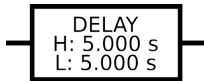

The Delay gate is able to delay the high or low value of the output signal. When you double-click on the gate, you can set the high (H) and low (L) values (in milliseconds). After you have made the wanted changes, click "Set" and upload the settings to the relay. There can be up to sixteen (16) Delay gates in use at any one time.

The image below displays an example where the Delay gate has been used to delay the signal from the input for 0.5 seconds before its sent to the output. When the input signal drops, the output signal is held for one second.

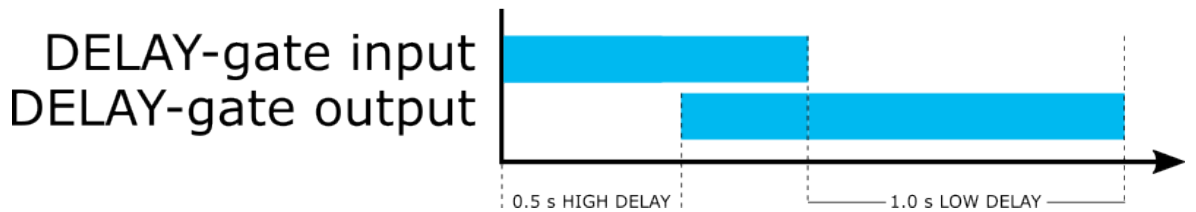
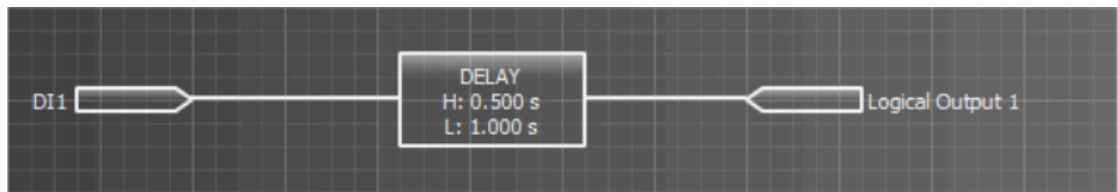

Edge gate



The Edge gate produces a 5 ms pulse when the D input receives a rising or a falling signal, depending on the R/F input's logic. If the R/F input is active, the output generates a pulse from a rising input signal. If the R/F input is not active, the output generate a pulse from falling edge.

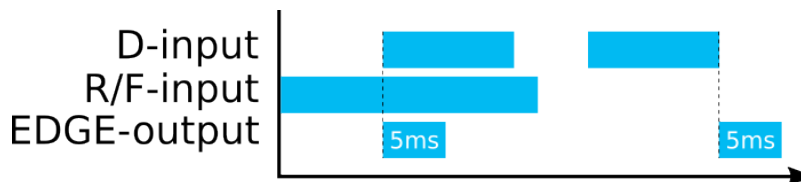
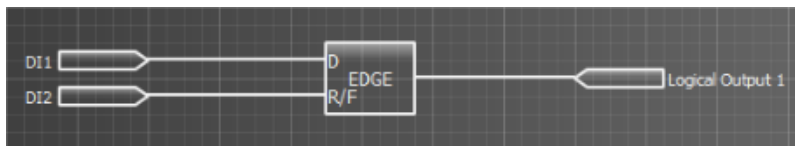

If you need a pulse longer than 5 ms, you can extend the pulse with the delay gate. In the image below the Delay gate has 0 s of high delay and 5 s of low delay, resulting in a five-second pulse.

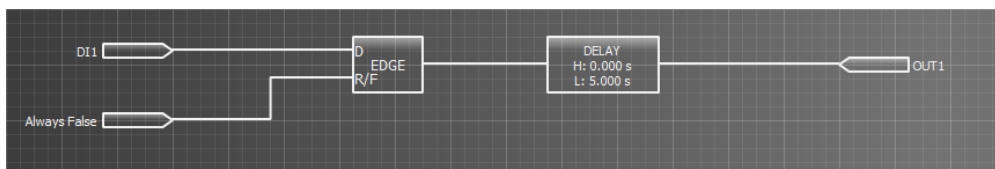

If the gate is only going to be used in the rising or falling edge mode, the easiest method to define that mode is to connect an "Always true" or an "Always false" signal to the R/F input.

Figure. 7.4.3 - 27. The truth table of the EDGE gate

R/F	D	Output
0	0	0
0	1	0
0	0 > 1	0
0	1 > 0	5 ms pulse
1	0	0
1	1	0
1	0 > 1	0
1	1 > 0	5 ms pulse

Latch gate



When a Latch gate receives a rising signal, its output remains active until the signal is cleared (see the image below). You can clear the signal by pushing the **Back** button on the relay's front panel.

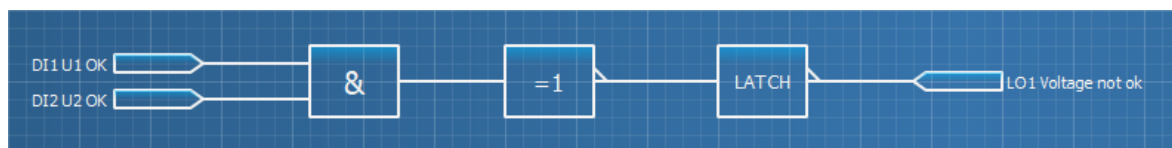
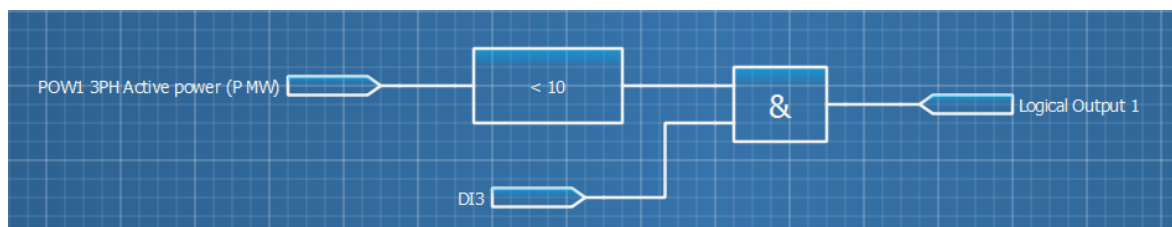

Figure. 7.4.3 - 28. The truth table of the LATCH gate

S	Back-button	Output
0	0	Previous
0	1	0
1	0	1
1	1	1

Analog input and analog comparator

Figure. 7.4.3 - 29. Logic example with analog input and comparator.



The analog comparator can be used to activate or disable the gate's output based on the measurement selected to the analog input. When adding the analog comparator to your logic, double-click on the gate to open a pop-up window (see the image below), where you can select the operator mode and the comparator value. In the example above, the analog input "3PH active power (P MW)" is connected to the analog comparator gate, where the value has been set to "10" and the operator mode is "<". This means that the analog comparator output gate is active whenever the three-phase active power is under 10 MW.

Figure. 7.4.3 - 30. Analog comparator settings.

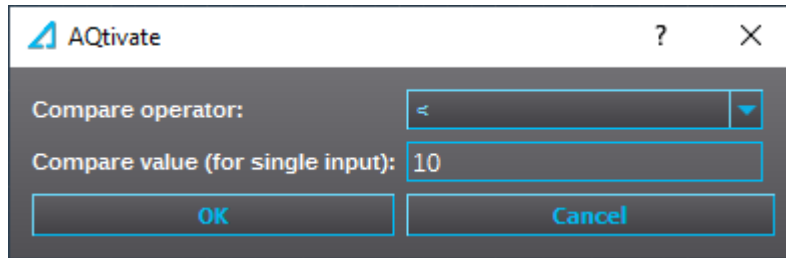

The analog comparator gate has six different operator modes, described in the table below:

Table. 7.4.3 - 4. Operator modes of the analog comparator gate.

Operator	Description
==	Equal to
!=	Not equal to
<	Less than
>	Greater than
<=	Less than or equal to
>=	Greater than or equal to

Notes

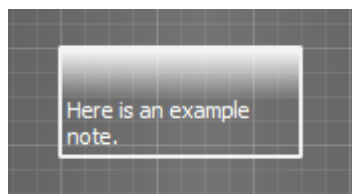

Notes can be used for describing logic programs for easier understanding.

Notes can be added by double-clicking the editor table and selecting "Note" from the pop-up window menu. You can start writing on the note by clicking the note's bottom row. You can also edit the note later by clicking the existing text.

7.5 Carousel Designer (AQ-210 series)

The number and content of the menus shown on the HMI display can be edited in Carousel Designer editor when an .aqs file is open.

Pressing the green "Plus" button adds a new view. You can select the type of the view from the drop-down menu. Once the carousel design is done, you can export the design into the .aq5 file that is currently open by pressing the "Export" button. To save the changes, click *File* → *Save* in AQtivate. You can send the changes to a relay by writing the Mimic to the relay at *Commands* → *Write to relay*. If you have an existing saved carousel menu, the "Import" button imports it to the currently open .aq5 file.

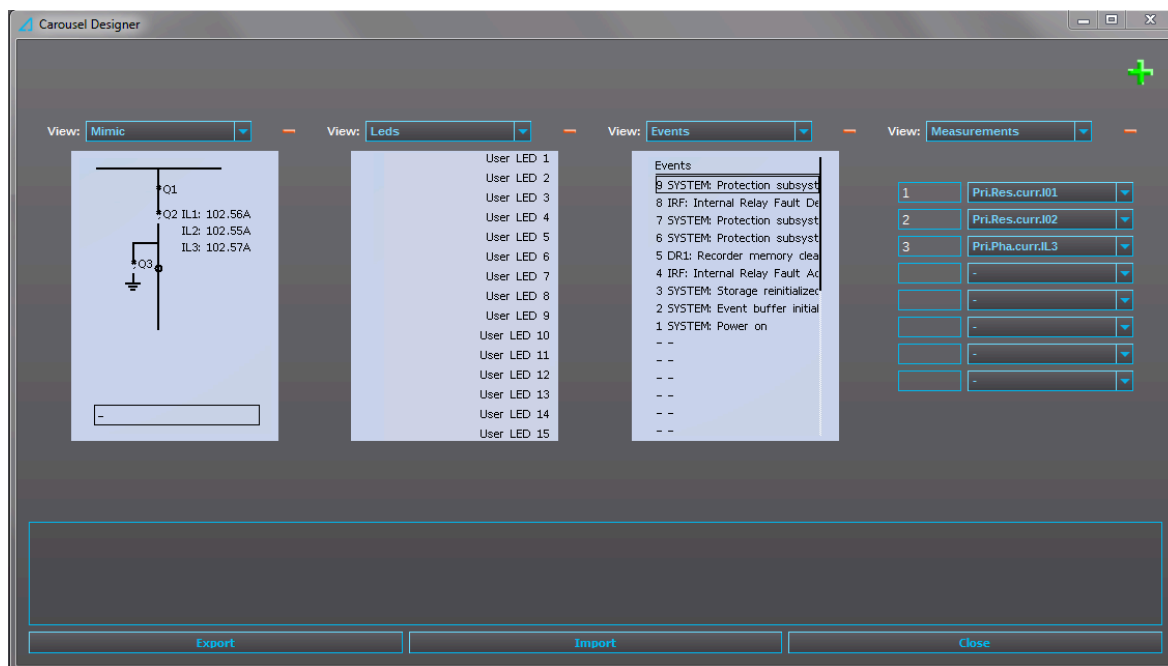

Types of carousel views available:

View name	Description
Mimic	Displays the unit's mimic. The mimic view image can be edited at <i>Tools</i> → <i>Mimic editor</i> .
Leds	Displays user-defined descriptions of the LEDs.
Events	Lists all of the events recorded by the unit.
Measurements	Displays measurements up to eight (8) lines. You can edit which measurements are shown at <i>Tools</i> → <i>Carousel Designer</i> .
Favorites	Shows the setting menus favorited by the user.
Clock	Displays the unit's time and date. The time and the date can also be set here.
Fault register	Displays the fault values recorded by the VREC function (not available in all AQ-210 series device types).
Alarms	Displays the activated alarms (available only in AQ-S214).

7.6 Carousel Designer (AQ-250 series)

The number and content of the menus shown on the HMI display can be edited in Carousel Designer editor when an .aq5 file is open.

Pressing the green "Plus" button adds a new view. You can select the type of the view from the drop-down menu. If there is more than one view on a page, the size of the view box can be changed with the thick white bar between the views. You can add and remove pages with the "Add page" and "Remove page" buttons. The order of the pages is determined by their position in the list on the left of the Carousel Designer window. Once the carousel design is done, you can export the design into the .aq5 file that is currently open by pressing the "Save" button (the floppy disk). You can send the changes to the relay by pressing the "Send to relay" button next to the "Save" button, or by the writing Mimic to the relay at *Commands* → *Write to relay*.

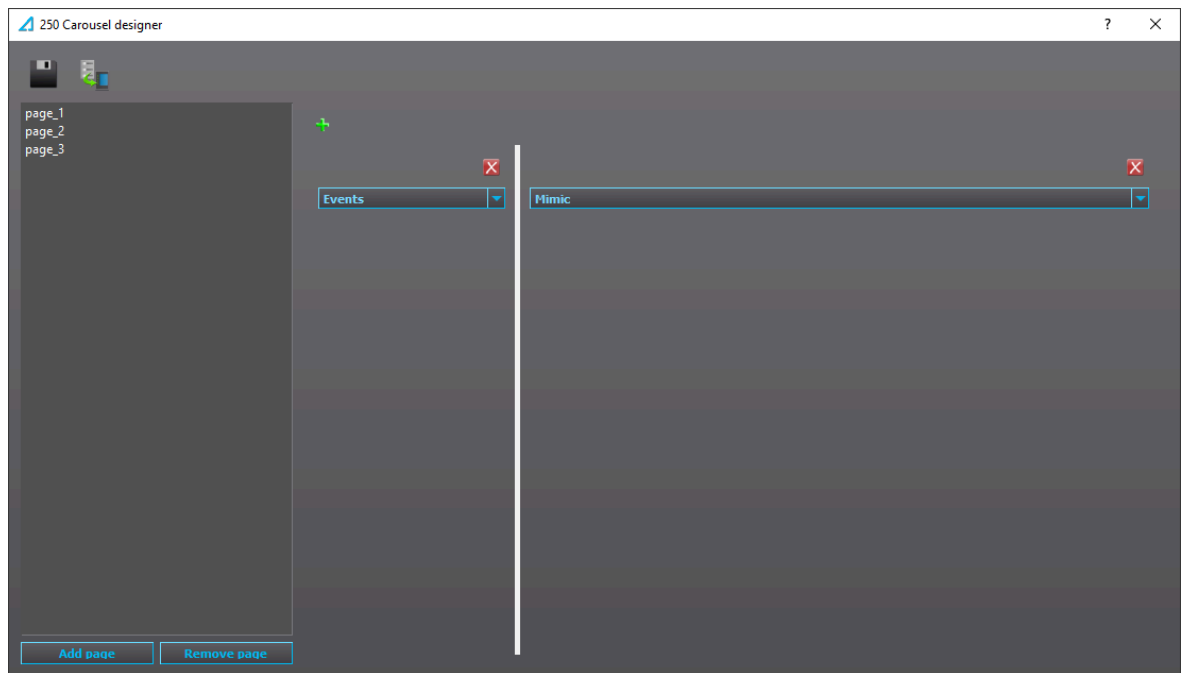

7.7 Project editor

Project editor is an optional project management tool. You can create a new project by clicking the "New project" button, creating a node called "Project". You can change the node's name by double-clicking it. If you right-click a node, a context menu appears. Right-clicking a node will open a context-menu. Selecting "Add substation" from this menu add a substation to the node. You can add bays to a substation by right-clicking a substation node and selecting "Add bay" from the context menu. Clicking on a bay node enables the menu on the right side of the node tree view. In this menu you can assign a setting file to the selected bay. The "." button opens a file dialog where you can select an .aqs file, and clicking the "Apply" button assigns this selected .aqs file to the selected bay. Once a setting file has been assigned, it can be opened by clicking the "Open .aqs" button. You can save a project by clicking the "Save project" button. A saved project can be opened by clicking the "Open project" button.

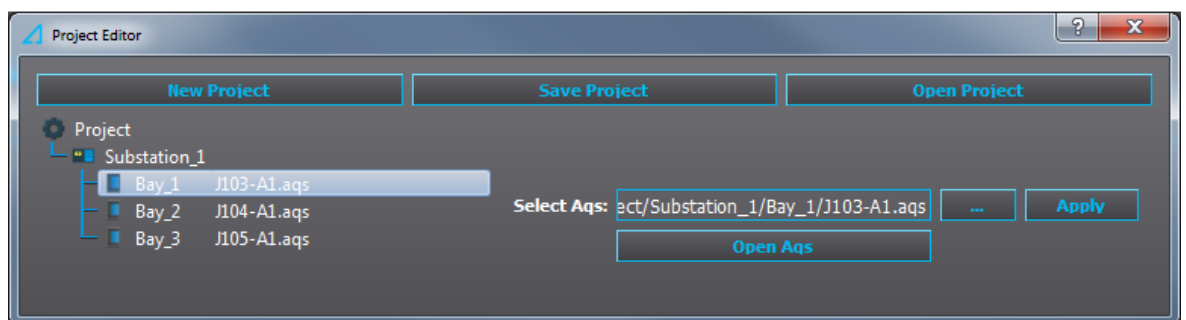

7.8 Wizard

The Wizard is an integrated tool inside the AQtivate configuration and setting tool. The wizards can be used to generate settings to Arcteq transformer protection relays.

The main benefits of the Wizard are the following:

- Easy to install and use (integrated in AQtivate)
- Its in-built user manual
- Easy to write differential and restricted earth-fault settings to a relay
- Direct feedback from the installation

Transformer Wizard

The wizard uses a selection of transformer-related information and other settings (such as CT specification and wiring) as the basis for building suitable setting parameters to the relay.

You can download the complete Transformer Wizard instructions ("Trafo Wizard Instructions Booklet") from arcteq.fi/downloads/ for more details.

The screenshot displays the AQtivate software interface for the Transformer Wizard. The window title is "AQtivate". The interface is split into two main panels. The left panel contains configuration fields for the transformer and its associated current transformers. The right panel shows a schematic diagram of the transformer and its connections.

High voltage side current transformer configuration:

- Ratio (primary/secondary): 100.0 / 1.0
- Rated power: 5.0 VA
- Class: 5 P 10
- Internal resistance: 0.05 Ω
- Other devices in series: 0.00 Ω
- Wire length to IED: 5.0 m
- % of wiring is 6w: 0 %
- Wire type: Copper 75°C
- Wire cross section: 4.0mm²
- Total burden: 0.0259 VA

Name plate values configuration:

- Transformer nominal power: 40.0 MVA
- HV side nominal voltage: 110.0 kV
- LV side nominal voltage: 20.0 kV
- HV/LV current transformer direction: Towards trafo
- Transformer Zk%: 12.00 %
- Transformer nominal frequency: 50.0 Hz
- Transformer magnetizing current: 3.0 %In
- Transformer vector group: Yy0
- Tap changer: LV side
- Tap steps max (nom.to +/-): 9 Steps
- Tap step effect: 1.67 %Un
- In-zone unit auxiliary transformer: No

The schematic diagram on the right shows a transformer with two windings. The top winding is connected to a switch and a current source S1. The bottom winding is connected to a switch and a current source S2. The high voltage side current transformer (HV CT) is connected to the top winding, and the low voltage side current transformer (LV CT) is connected to the bottom winding. The HV CT terminals are labeled P1 and P2, and the LV CT terminals are labeled P2 and P1.

Generator Wizard

The wizard uses a selection of generator-related information and other settings (such as CT specification and wiring) as the basis for building suitable setting parameters to the relay.

The screenshot displays the AQtivate 200 software interface, divided into two main sections: 'Application' settings and a 'Current transformers' table, alongside a single-line diagram of a generator system.

Application Settings:

- User mode: Regular
- Generator type: Salient pole
- Generator excitation: Brushless
- Prime mover: Diesel
- Generator grounding: Resistance grounded (NER)
- Generator ground measurement: None
- Step-up transformer: Individual
- Step-up transformer reactance influence: Disabled
- Voltage measurement: Grid side
- Generator differential: No
- Auxiliary load inside protected zone: No
- Integrated synchronizer: No
- Integrated rotor earth-fault: No
- Permanent island mode: No
- System reactance influence: Disabled

Current transformers Table:

Parameter	Value
Phase CT; Internal resistance	0,05 Ω
(This is hidden value)	0,005
Phase CT; Wiring length	5,0 m
Phase CT; % of wiring is 6w	0 %
Phase CT; Wire type	Copper 75°C
Phase CT; Wire resistance	0,01350 Ω/m
Phase CT; Wire cross section	4.0mm ²
Phase CT; Direction	Towards load

Single-line Diagram:

The diagram shows a 3LN relay voltage connection at the top, with a transformer ratio of $\frac{4.160 \text{ kV}}{\sqrt{3}} / \frac{110.0 \text{ V}}{\sqrt{3}}$. Below this is a 425.000 MVA (YNd 11) transformer with a 145.000 / 19.000 kV ratio (425.000 MVA base). The generator (G) is connected to the secondary of the transformer. The generator parameters are: 161.200 MVA (161.200 MVA base), 123.400 MW, $X_d = 1.946 \text{ pu}$, 0.77 P.F., $X'_d = 0.2790 \text{ pu}$, 20.000 kV, $X''_d = 0.1940 \text{ pu}$, 3PH, 50 Hz, $X_q = 0.7800 \text{ pu}$. The generator is connected to a 500.0 / 1.0 A (3PH) 5 P 10 (5.0 VA) meter. The generator is grounded through a Neutral Earth Resistor (NER) with a value of 10 A.

7.9 Events and logs

7.9.1 Event history

The "Event history" window displays the time-stamped events. These can be e.g pick-ups, trips, or blocks. You can find more information about event masks in the selected function's "Events" tab. Event masks determine what is recorded into the event history; they are configured in each function's individual settings in the *Protection*, *Control* and *Monitoring* menu. The event history can be exported as a separate text file (.txt) by clicking the "Save" button (the floppy disk icon).

When you click the "Show new events only" button, AQtivate shows only those events that happen from that point on. Clicking the "Show all events" button switches back to the view that shows all events.

If you want to see the time difference between two events, right-click on an event and select "Add to compare [x]" from the context menu.

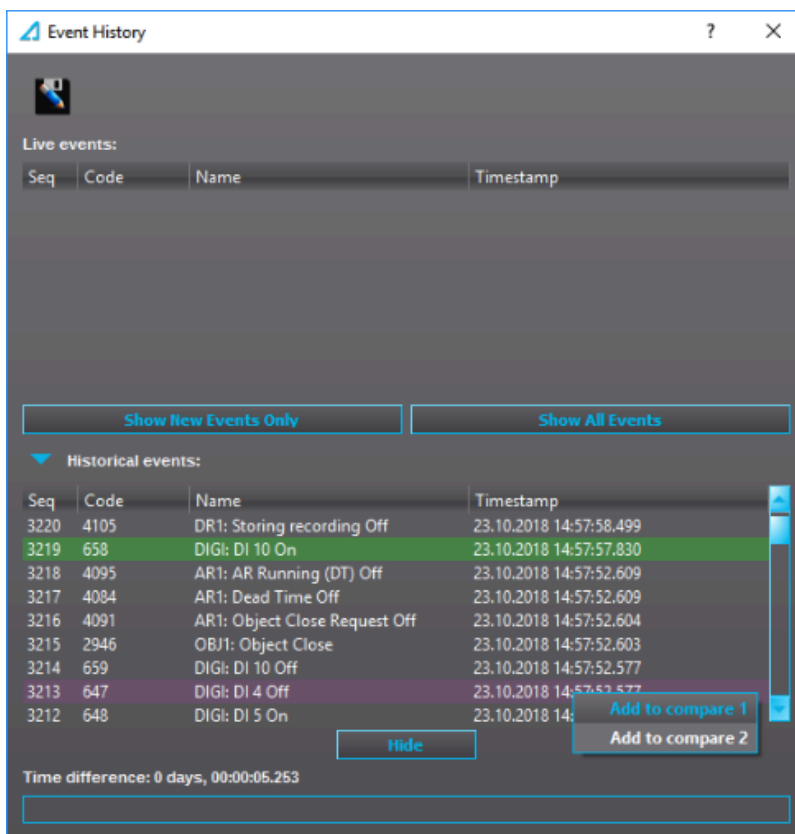

Event lists can also be filtered to show specific events. This filtering is done by writing in the text box at the bottom of the window. Below is an example where "TRIP ON" has been written in the text box to only display events that contain the text "TRIP ON". Please note that the tool does not differentiate between lower and upper case: writing "trip on", "Trip on" or "tRiP oN" all bring up the same events in the example.

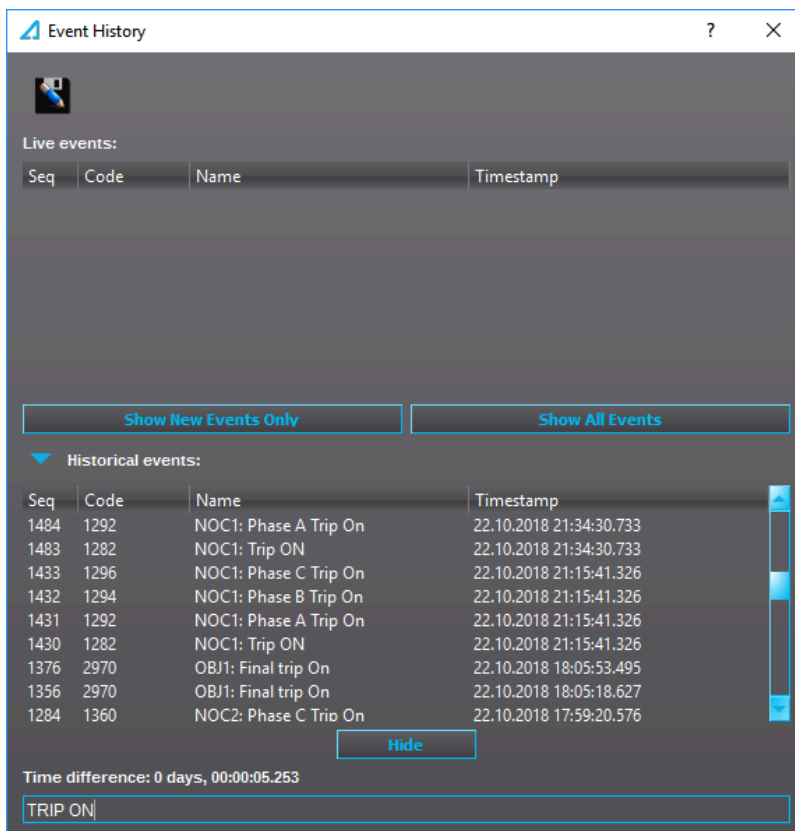

7.9.2 Event list

You can access a list of all possible events by opening the "Event list" from the *Tools* menu. Each event has an event code and a SPA event channel. This list can also be saved as a text file by clicking the "Save" button (the floppy disk icon).

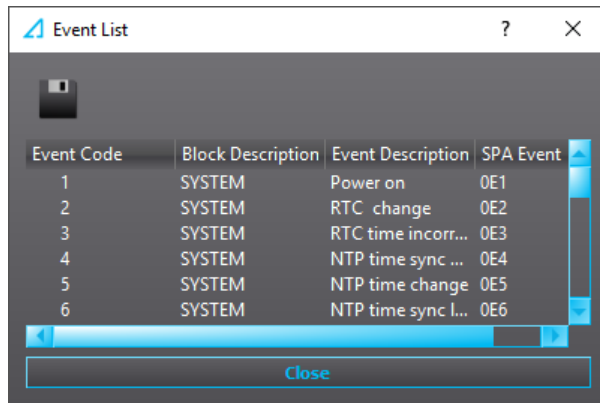

7.9.3 Configuration change log

The configuration change log can be used to observe parameter changes made to the relay. The configuration change log records the parameter, the new value and the time of change.

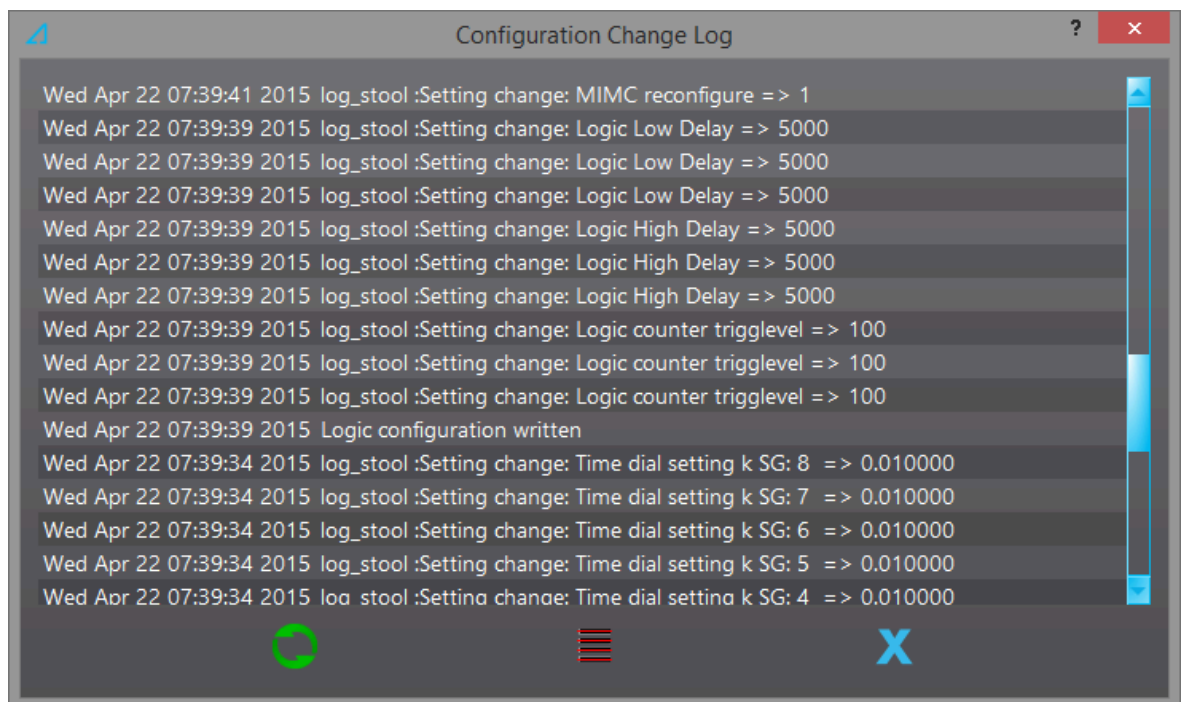

7.9.4 Set alarm events

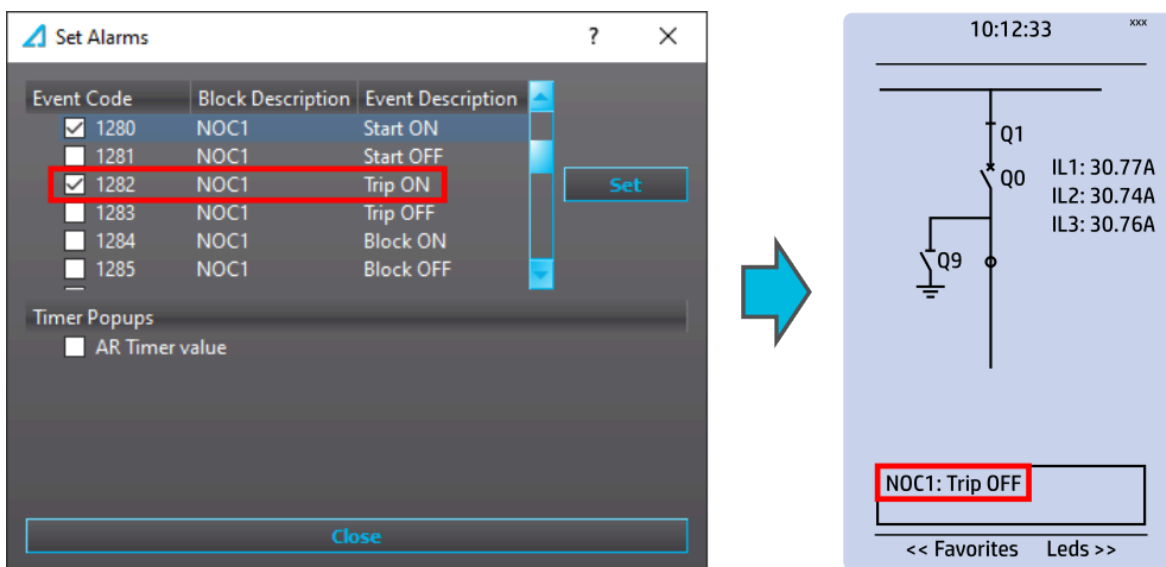

Alarm events can be set by using this dialog. You can select which events cause alarms in the relay by checking the respective boxes in the "Set alarms" window and then pressing the "Set" button (see the image above, on the left). When one of the alarm events occurs, it is shown in the relay's mimic view (see the image above, on the right). The newest alarm is always displayed, and it can be cleared with the HMI's **Back** button. Up to five (5) alarm events can be stored at any one time; when all five slots are full, the oldest alarm is deleted to make way for new alarms. Please note that the mimic view must be enabled in the Carousel designer.

If the auto-recloser is in use, checking the "AR Timer" box enables a timer that displays the remaining dead time or reset time.

NOTE!



The event that is to be recorded has to be activated also in the event mask of the function in question.

7.10 Communication

7.10.1 IEC 61850

Figure. 7.10.1 - 31. Main view of IEC61850 editor.

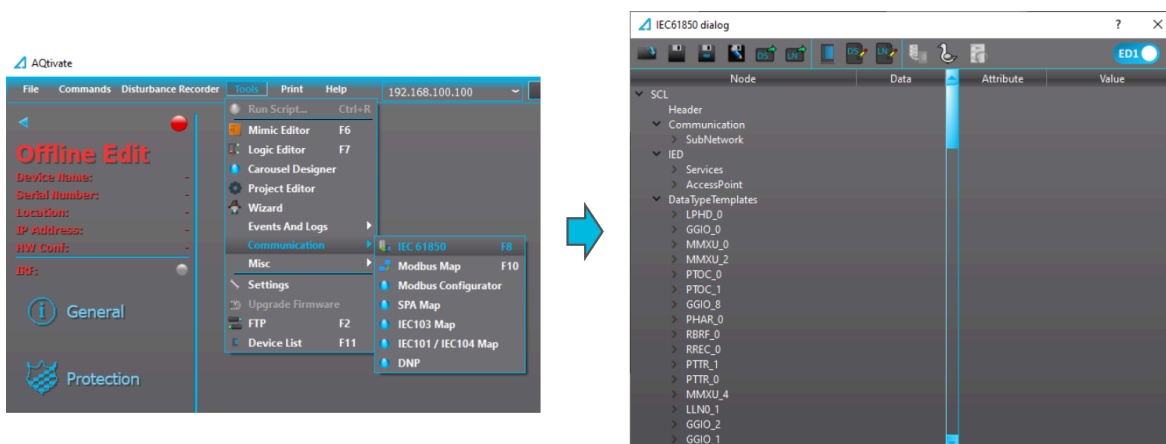

The user can enable the IEC 61850 protocol in device models that support this protocol at *Communication* → *Protocols* → *IEC61850*. AQ-21x frame units support Edition 1 of IEC 61850. AQ-25x frame units support both Edition 1 and 2 of IEC61850. The following services are supported by IEC 61850 in Arcteq devices:

- Up to six data sets (predefined data sets can be edited with the IEC 61850 tool in AQtivate)
- Report Control Blocks (both buffered and unbuffered reporting)
- Control ('Direct operate with normal security', 'Select before operate with normal security', 'Direct with enhanced security' and 'Select before operate with enhanced security' control sequences)
- Disturbance recording file transfer
- GOOSE
- Time synchronization

The device's current IEC 61850 setup can be viewed and edited with the IEC61850 tool (*Tools* → *Communication* → *IEC 61850*). By browsing the 61850 tree one can see the full list of available logical nodes in the Arcteq implementation.

IEC 61850 main toolbar

Figure. 7.10.1 - 32. Main toolbar.

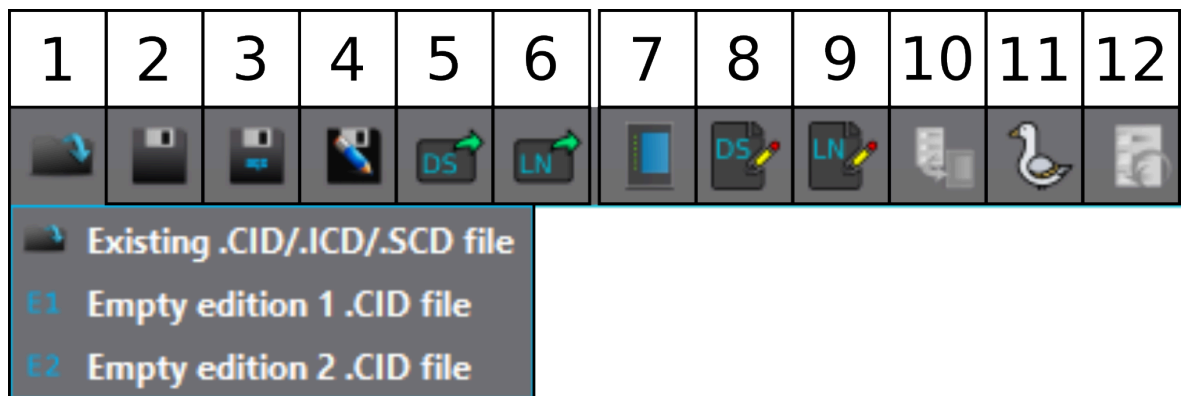

The buttons available in the main toolbar of the IEC 61850 tool are (as per image):

1. Open .CID/.ICD file
 - a) Open an existing .CID/.ICD/.SCD file from the PC's hard drive.
 - b) Open empty Edition 1 .CID file
 - c) Open empty Edition 2 .CID file
2. Save .CID/.ICD file
If a .CID file was opened from PC's hard drive, saves all changes to that .CID or .ICD file.
3. Save to .aqz
Saves the .CID or .ICD file into the .aqz currently open (remember to save the .aqz file as well [*File* → *Save*] to keep the changes!).
4. Save .CID/.ICD as...
Saves the .CID or .ICD file on the PC's hard drive as a separate .CID or .ICD file.
5. Export data set info
Exports the data set information into a .txt file which can then be viewed in table format with tools such as Excel.
6. Export logical node info
Exports the info of logical nodes currently activated into a .txt file which can then be viewed in table format with tools such as Excel.
7. Configurations
Opens the main configurations pop-up window.
8. Edit data sets
Opens the data set editing window.

9. Edit logical nodes
Opens the logical node editing window. Used for enabling and disabling logical nodes.
10. Send to relay
Sends the .CID/.ICD configurations to the relay (requires a connection to the relay).
11. Import GOOSE settings
Imports predefined GOOSE settings from another .CID/.ICD file and connects them to GOOSE inputs.
12. Get default .CID/.ICD file from the relay
Retrieves the default .CID/.ICD file from the relay (requires a connection to the relay).

Configurations



The main configurations dialog window is opened by pressing the seventh button ("Configurations") in the main toolbar. The most important parameters here are the "IED name" and the "IP" settings. Additionally, if the intention is to use the GOOSE publisher service, the parameters for GCB1 and GCB2 should also be set. See the following image of the main configuration window for the basic settings and the settings for GOOSE publishing.

Figure. 7.10.1 - 33. Configurations window.

IEC61850 configuration dialog ? X

<p>MAIN CONFIG</p> <p>Subnetwork name: <input type="text" value="SubNetworkName"/></p> <p>AP ID: <input type="text" value="1,1,9999,1"/></p> <p>AE qualifier: <input type="text" value="12"/></p> <p>P selector: <input type="text" value="00000001"/></p> <p>S selector: <input type="text" value="0001"/></p> <p>T selector: <input type="text" value="0001"/></p> <p>IP: <input type="text" value="192.168.100.100"/></p> <p>Subnet mask: <input type="text" value="255.255.255.0"/></p> <p>Gateway: <input type="text" value="192.168.1.1"/></p> <p>MAC address: <input type="text" value="80-1F-12-C1-A8-F6"/></p> <p>IED name: <input type="text" value="AQx2xx"/></p> <p>Object control model: <input type="text" value="Direct with normal security"/></p> <p>Config version: <input type="text" value="1.0"/></p>	<p>GCB 1</p> <p>App ID: <input type="text" value="0"/></p> <p>VLAN priority: <input type="text" value="4"/></p> <p>VLAN ID: <input type="text" value="0"/></p> <p>MAC address: <input type="text" value="01-0C-CD-01-00-00"/></p> <p>Conf rev: <input type="text" value="1"/></p> <p>GCB 2</p> <p>App ID: <input type="text" value="1"/></p> <p>VLAN priority: <input type="text" value="4"/></p> <p>VLAN ID: <input type="text" value="0"/></p> <p>MAC address: <input type="text" value="01-0C-CD-01-00-00"/></p> <p>Conf rev: <input type="text" value="1"/></p>
-----------------------------------------------------------------------------------------------------------------------------------------------------------------------------------------------------------------------------------------------------------------------------------------------------------------------------------------------------------------------------------------------------------------------------------------------------------------------------------------------------------------------------------------------------------------------------------------------------------------------------------------------------------------------------------------------------------------------------------------------------------------------------------------------------------------------------------	-----------------------------------------------------------------------------------------------------------------------------------------------------------------------------------------------------------------------------------------------------------------------------------------------------------------------------------------------------------------------------------------------------------------------------------------------------------------------------------------------------------------------------------------------------------------------------------

Edit logical nodes



Logical node editor can be opened by pressing the ninth button on the main toolbar. Logical node editor is used for selecting which logical nodes are available in the data set editor. If a logical node is selected in the "Edit logical nodes" tool, it is possible to add that logical node to a data set in the "Data set editor".

Figure. 7.10.1 - 34. Edit logical nodes window.

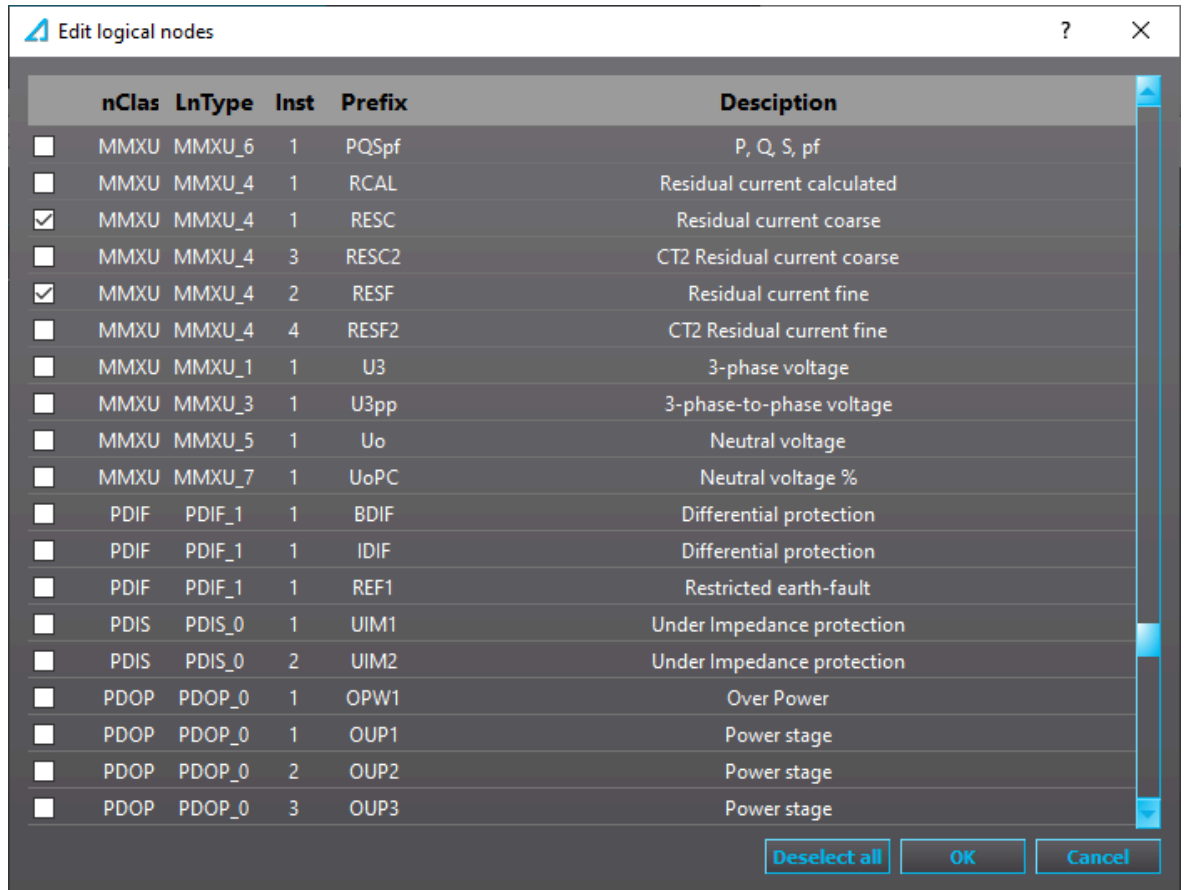

Data sets



The data set editing window is opened by pressing the eighth button on the main toolbar. Data sets can be added and removed by using the "+" and "-" buttons, respectively. Up to six data sets can be used. When a data set has been added, it must be assigned to a Report Control Block with the "RCB" button. This opens a new pop-up window. The assigning can be either to unbuffered reporting (URCBs) or to buffered reporting (BRCBs).

If both of the GOOSE publisher data sets are un-checked, the GOOSE publisher service is disabled (see the image below).

Figure. 7.10.1 - 35. Data set editing window.

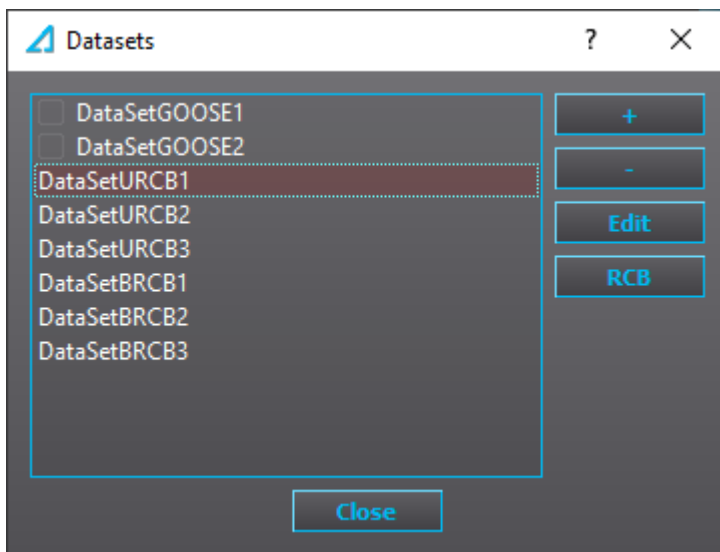

To edit data sets report control block properties, select the data set and click "RCB" button. In RCB settings you can set the name of the RCB, if the data set is buffered or not, buffering time (if the data set is buffered), maximum amount of clients that can connect to the data set at a time, configuration revision and integrity period. Integrity period can be used to force the data set to refresh the data set even when there hasn't been any change.

Figure. 7.10.1 - 36. Report control block settings

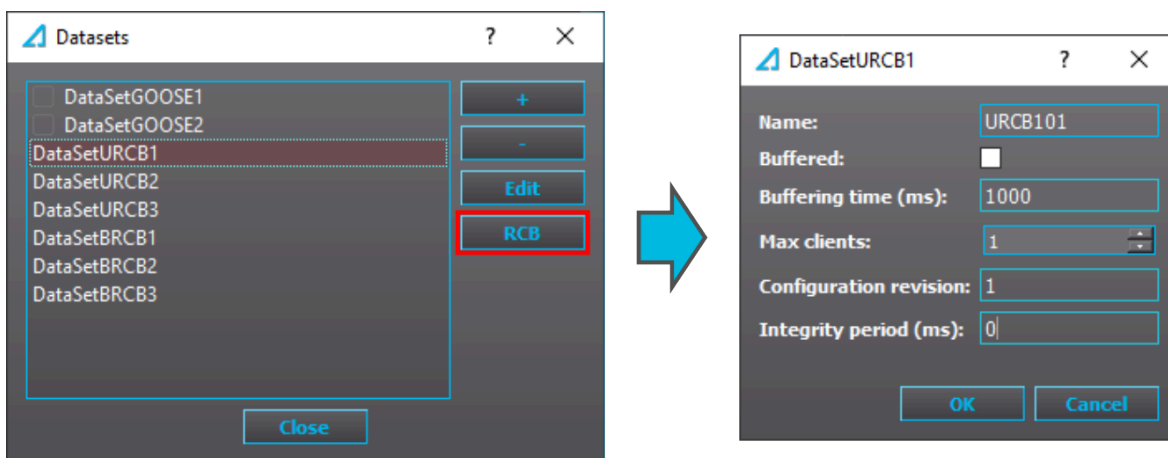

All data sets can be edited. The data set editing dialog is opened by selecting the data set to be edited and then clicking the "Edit" button. The editing dialog shows all currently configured entries of the data set. An entry can be removed from the data set by clicking the red "-" button located at the end of the entry's row. New entries can be added and old ones edited by clicking the green "+" button at the top right of the window. "Edit dataset" window will list all logical nodes that have been activated in "Edit logical nodes" window. For URCB and BRCB data sets it is recommended that the data is selected on the doName (data object) level (see the image below). This way all available information (such as status, quality, and time) is always sent in the report.



NOTE!

Up to 65 signals can be added to each data set.

Data can also be selected on daName (data attribute) level, which selects each individual piece of data. This approach may be preferred for GOOSE data sets. The nature of GOOSE communication is such that same frame is repeatedly sent. The interval between frames is increasing until reaching 2 seconds, which is the keep-alive rate. If a data value in the GOOSE dataset changes the interval is reduced again. Timestamp information in this kind of communication is not relevant. In GOOSE datasets we recommend that only value and quality attributes are added.

Figure. 7.10.1 - 37. Data selection on the data attribute level.

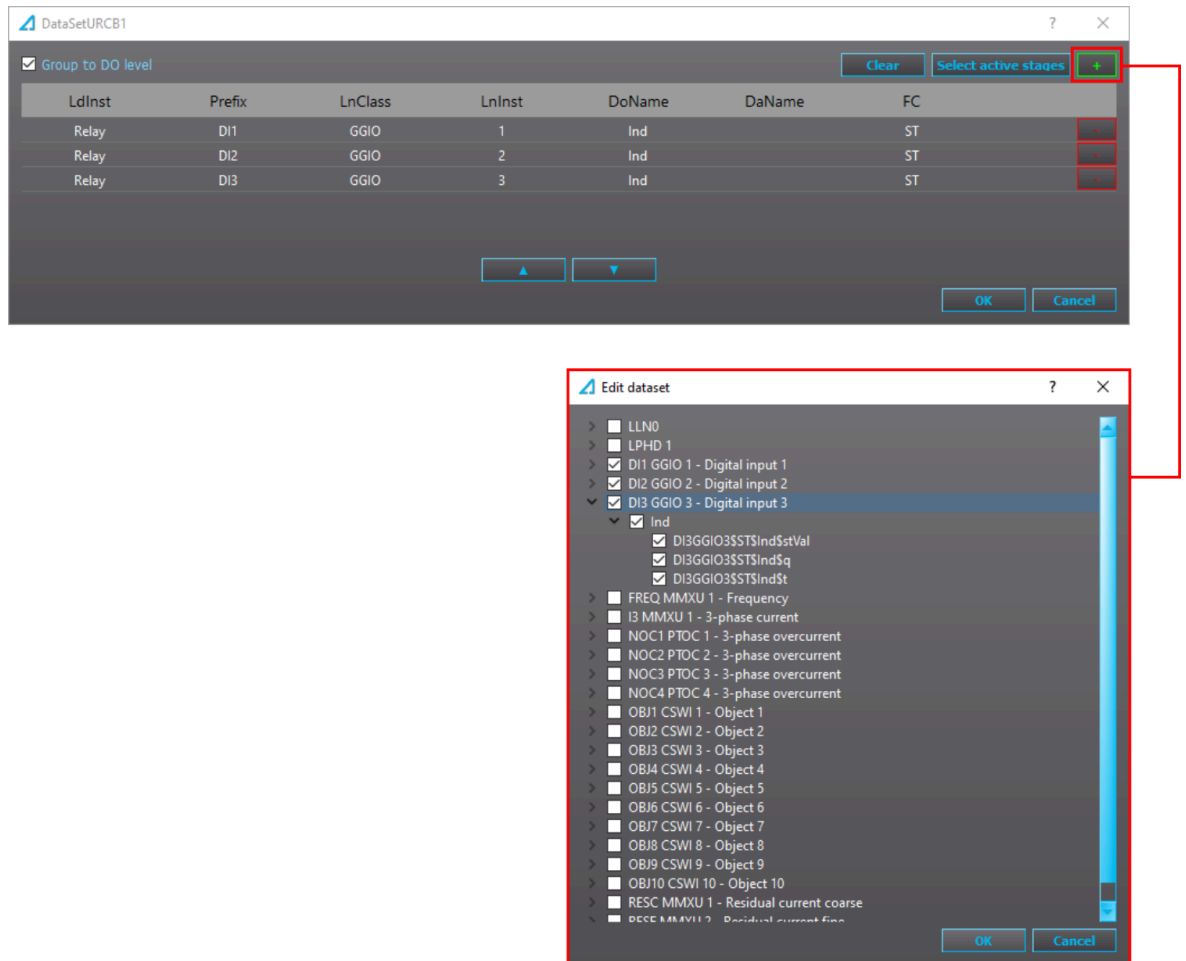

Settings.

The general setting parameters for the IEC 61850 protocol are visible both in AQtivate and in the local HMI (*Communication* → *Protocols* → *IEC61850*). The settings are described in the table below.

Table. 7.10.1 - 5. General settings.

Name	Range	Step	Default	Description
Enable IEC 61850	0: Disabled 1: Enabled	-	0: Disabled	Enables and disables the IEC 61850 communication protocol.
IP port	0...65 535	1	102	Defines the IP port used by the IEC 61850 protocol. The standard (and default) port is 102.
General deadband	0.1...10.0 %	0.1 %	2 %	Determines the general data reporting deadband settings.
Active energy deadband	0.1...1000.0 kWh	0.1 kWh	2 kWh	Determines the data reporting deadband settings for this measurement.

Name	Range	Step	Default	Description
Reactive energy deadband	0.1...1000.0 kVar	0.1 kVar	2 kVar	Determines the data reporting deadband settings for this measurement.
Active power deadband	0.1...1000.0 kW	0.1 kW	2 kW	Determines the data reporting deadband settings for this measurement.
Reactive power deadband	0.1...1000.0 kVar	0.1 kVar	2 kVar	Determines the data reporting deadband settings for this measurement.
Apparent power deadband	0.1...1000.0 kVA	0.1 kVA	2 kVA	Determines the data reporting deadband settings for this measurement.
Power factor deadband	0.01...0.99	0.01	0.05	Determines the data reporting deadband settings for this measurement.
Frequency deadband	0.01...1.00 Hz	0.01 Hz	0.1 Hz	Determines the data reporting deadband settings for this measurement.
Current deadband	0.01...50.00 A	0.01 A	5 A	Determines the data reporting deadband settings for this measurement.
Residual current deadband	0.01...50.00 A	0.01 A	0.2 A	Determines the data reporting deadband settings for this measurement.
Voltage deadband	0.01...5000.00 V	0.01 V	200 V	Determines the data reporting deadband settings for this measurement.
Residual voltage deadband	0.01...5000.00 V	0.01 V	200 V	Determines the data reporting deadband settings for this measurement.
Angle measurement deadband	0.1...5.0 deg	0.1 deg	1 deg	Determines the data reporting deadband settings for this measurement.
Integration time	0...10 000 ms	1 ms	0 ms	Displays the integration time of the protocol. If this parameter is set to "0 ms", no integration time is in use.
Reconfigure GOOSE	0: - 1: Reconfigure	-	0: -	Reconfigures the GOOSE.
Enable GOOSE subscriber	0: Disabled 1: Enabled	-	0: Disabled	Enabled and disables the GOOSE subscriber.

For more information on the IEC 61850 communication protocol support, please refer to the conformance statement documents (www.arcteq.fi/downloads/ → AQ-200 series → Resources).

GOOSE publisher

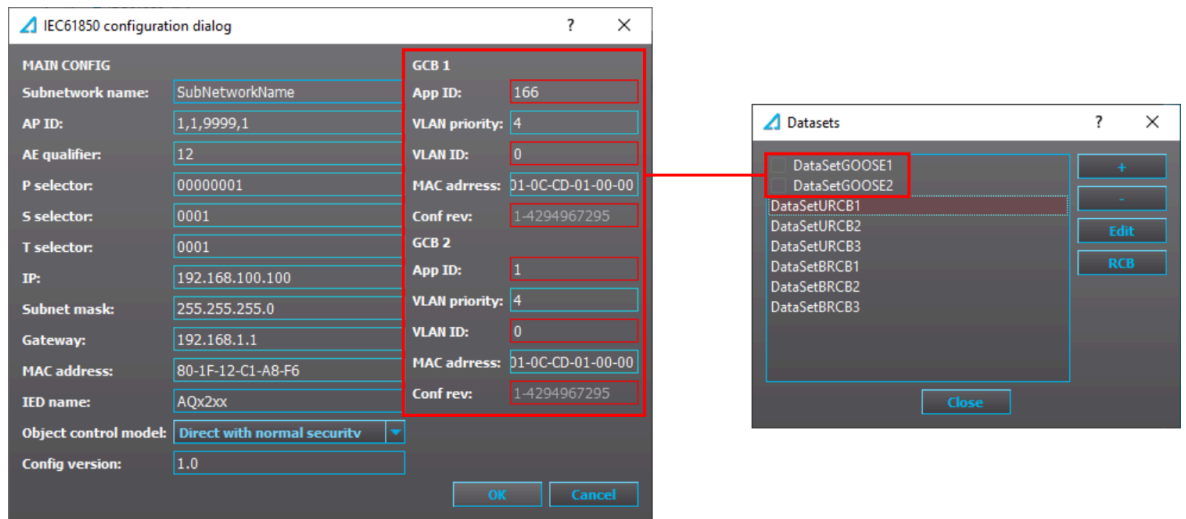

On the right side in the configurations dialog are the 2 GOOSE control block parameters. These are used to configure GOOSE publisher. App ID stands for Application Identification. This hexadecimal parameter defines the ID of published GOOSE data from this unit. There are 2 GOOSE control blocks available in the device. The App ID must be unique in the network. The App ID is used in the subscriber to identify the incoming GOOSE data frame. VLAN Priority can together with VLAN ID parameter be used to build sub-networks in the system utilizing intelligent switches. MAC-Address defines the multicast address to which the GOOSE publisher is sending its frames. Conf Rev. stands for configuration revision. It can be considered to be the version number of the GOOSE dataset.

Figure. 7.10.1 - 38. Example of GOOSE publisher signal setup.

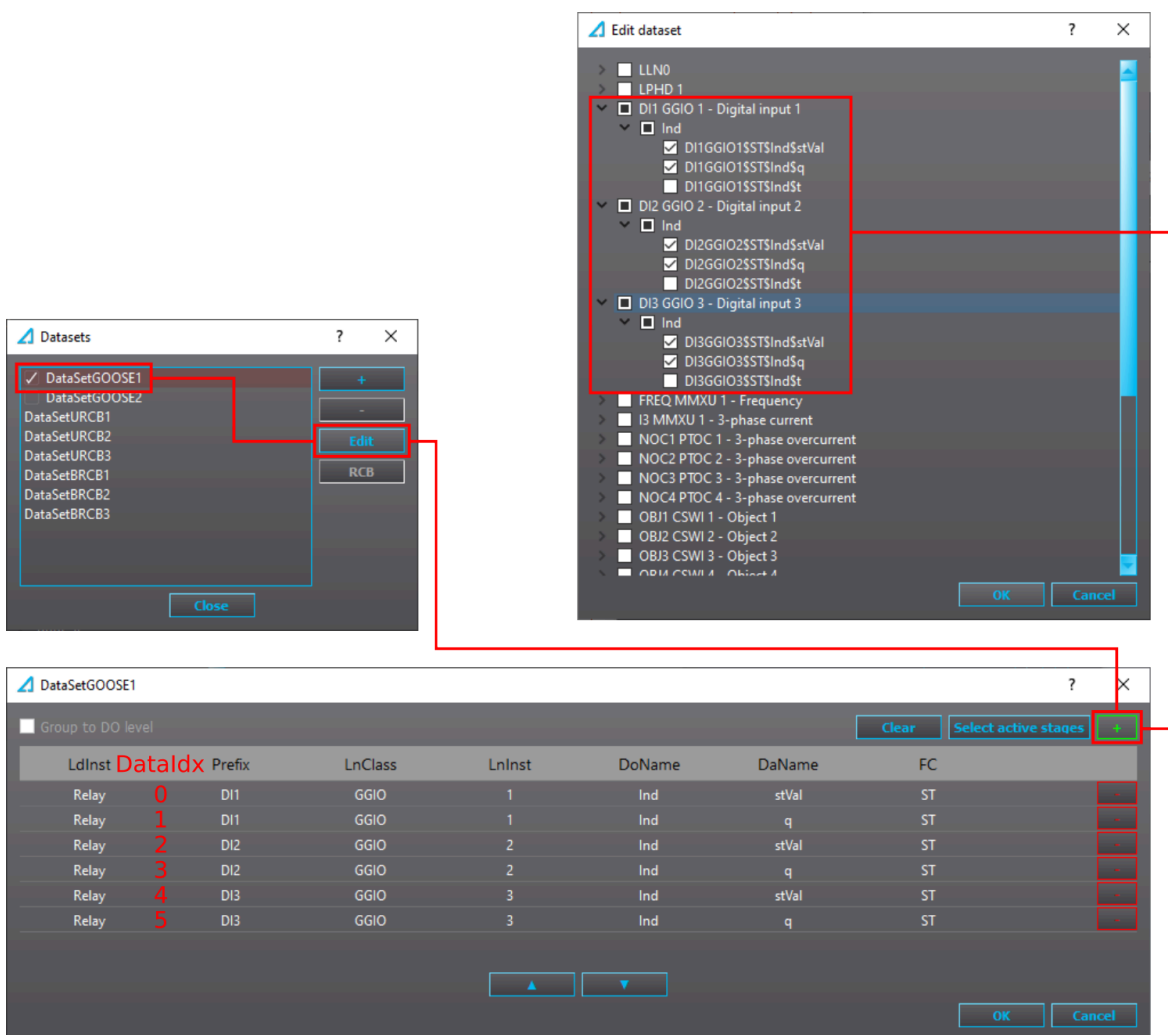

In the example above is a typical setup for GOOSE subscriber data set. GOOSE data set 1 is enabled with a checkbox. The status (stVal) and quality (q) of three first digital inputs are added to the data set. Each signal then has a dataindex starting from zero and counting up.



NOTE!

Both GOOSE data sets can hold up to 16 signals each.

GOOSE subscribing

GOOSE subscriber is enabled with *GOOSE subscriber enable* parameter under *Communication* → *Protocols* → *IEC61850* view. There are 64 independent GOOSE inputs available in the device. For each of the inputs there are 5 settings: In use, Appld, ConfRev, Dataldx and Nextldx is quality. These settings are used to pair an input with single data in published frames in the system.

Figure. 7.10.1 - 39. Example GOOSE subscriber settings.



In the picture above GOOSE Input 1 has been configured to receive the DI1 input value that was configured in the previous chapter's configuration. NextIdx is quality has been enabled which means that relay will assume the next DataIdx ($0+1 = 1$) to be quality of the same GOOSE signal.

In the picture above the GOOSE input was configured manually. GOOSE inputs can be also configured by importing the GOOSE publishers CID file and assigning signals to GOOSE inputs. This can be done at "GOOSE settings" menu at IEC61850 editor.

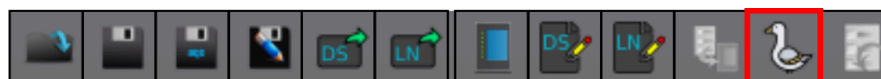

GOOSE subscription info

Edition 1 CID file doesn't contain GOOSE subscription info.
To send settings to the relay, import settings in "Live Edit" mode or use "Commands -> Write to relay -> Settings" afterwards.

GOOSE input	IED name	LdInst	Prefix	LnClass	LnInst	DoName	DaName	Next quality
1	AQx2xx	Relay	D11	GGIO	1	Ind	stVal	True
2	AQx2xx	Relay	D12	GGIO	2	Ind	stVal	True
3	AQx2xx	Relay	D13	GGIO	3	Ind	stVal	True

Close

7.10.2 Modbus map

You can access the Modbus-related information by opening the "Modbus map" dialog from the *Tools* → *Communication* menu. The Modbus map can be saved as a text file by clicking the "Save" button (the floppy disk icon).

Modbus Map

Configure

Holding Register	Parameter	Access	Length	Info
HR1	Modbus requests	R/W=0	1	Diagnostic request counter
HR2	Modbus quality	R	1	Diagnostic quality
HR3	Modbus errors	R/W=0	1	Diagnostic error counter
HR4	Modbus Ctrl OK	R/W=0	1	Diagnostic Control OK counter
HR5	Modbus Ctrl Errors	R/W=0	1	Diagnostic Control Error counter
HR6	Object1 control register	R=0/W	1	SELECTOPEN=0xA001 SELECTCLOSE=0xA002,CANCEL=0xA...
HR7	Object2 control register	R=0/W	1	SELECTOPEN=0xA001 SELECTCLOSE=0xA002,CANCEL=0xA...
HR8	Object3 control register	R=0/W	1	SELECTOPEN=0xA001 SELECTCLOSE=0xA002,CANCEL=0xA...
HR9	Object4 control register	R=0/W	1	SELECTOPEN=0xA001 SELECTCLOSE=0xA002,CANCEL=0xA...
HR10	Object5 control register	R=0/W	1	SELECTOPEN=0xA001 SELECTCLOSE=0xA002,CANCEL=0xA...
HR11	Previous Event register	R	6	Event code
HR12	Previous Event register	R	6	Event timestamp (ms)
HR13	Previous Event register	R	6	Event timestamp (sec Hi-16bits)
HR14	Previous Event register	R	6	Event timestamp (sec Lo-16bits)
HR15	Previous Event register	R	6	Event sequential index
HR16	Previous Event register	R	6	RESERVED

Close

AQtivate

HR	Source register	Length
8001	1261	1
8002	1262	1
8003	1263	1

Close Send to relay Save config

All signal holding registers in the default map are fixed, i.e. they cannot be edited by the user. If you need custom holding registers, you can use the Modbus configurator to change the used Modbus map. The Modbus configurator can be found at *Tools* → *Communication* → *Modbus configurator*. The fixed holding registers can be also reassigned to user-defined holding registers with the "Configure" button in the Modbus map window. This brings up a smaller pop-up window, where you can add a new row by right-clicking and choosing "Add". Then you can choose the holding register you want to use in the new holding register. The holding registers that users can edit start their numbering from 8001.

7.10.3 Modbus configurator

This tool is used to make changes to the register map when communicating using a Modbus protocol.

Available buttons

Button	Description
	Load old configuration
	Preview
	Export to .txt
	Save to .aqs
	Send to .aqs
	Sort by HR
	Delete HR(s)
	Undo
	Redo

Terms

Term	Description
Holding register (HR)	An object type in Modbus, has Read-Write access, 16 bits in size.
Default map	The static Modbus map that has been used by the relay.

Term	Description
Configurable map	The new Modbus map that can be altered.

Usage

The default map is unconfigurable while the configurable map is there for the user to change. If no configuration has been made, it will be a copy of the default map.

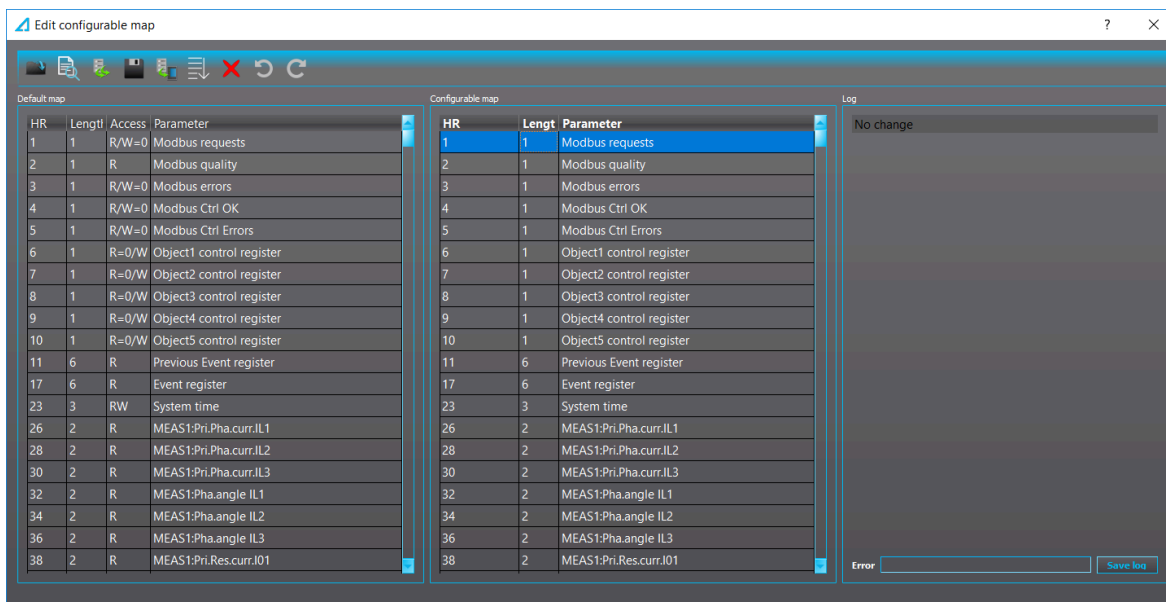

Limitations

The configurable map is set to only hold 10,000 rows at maximum. In each row, the sum of the values in columns "HR" and "Length" cannot exceed 65,535.

When one of the limitations is reached, the user is notified and they should undo the latest action.

Load old configuration

If there are configurations made by the old configuration dialog, there is a button to import it in the toolbar. The old configurations are typically imported once when the new configuration dialog is first used.

If there are configurations made by the new configuration dialog, the configurations are be loaded automatically. The loading steps are shown in the log section.

Add data

New data can be copied from the default map to the configurable map following these steps:

- Choosing the row(s) needed to be copied in the default map.
- Drag the selected row(s).
- Drop the data onto the configurable map.

The new data is appended to the configurable map.

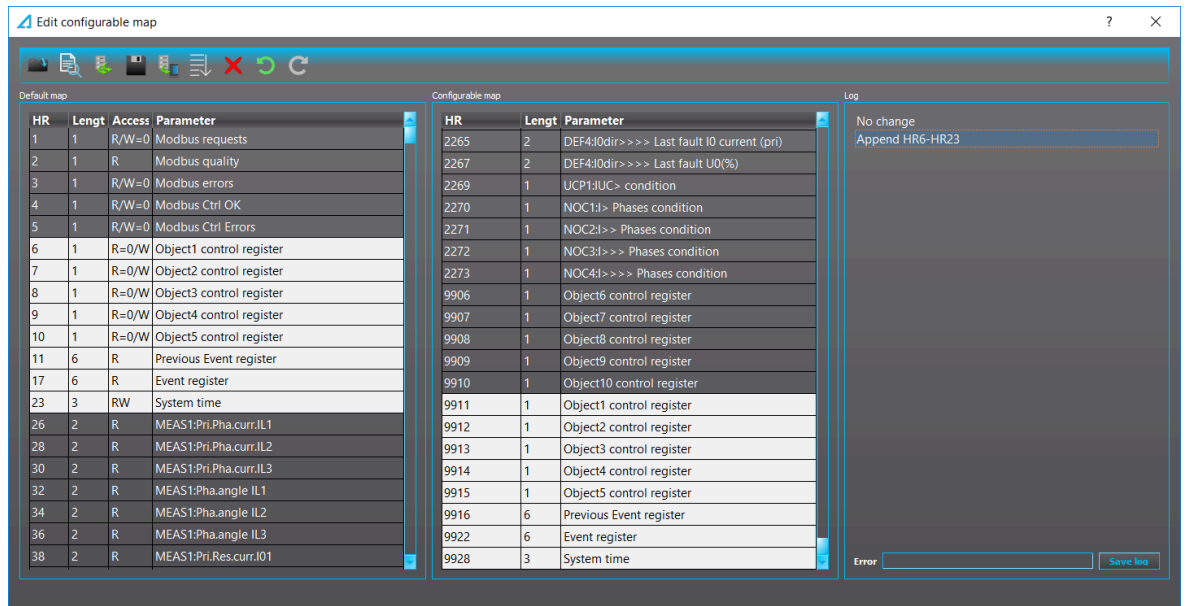

Change HR

The HR can be changed by double-clicking the HR column of the wanted parameter. You can use the arrow buttons or the keyboard arrow keys to set the desired HR. Before the HR is changed, if there is another data at that destination, the user is notified of the conflict and given two choices:

- Delete the current data at the destination ("Yes").
- Cancel the change ("No").

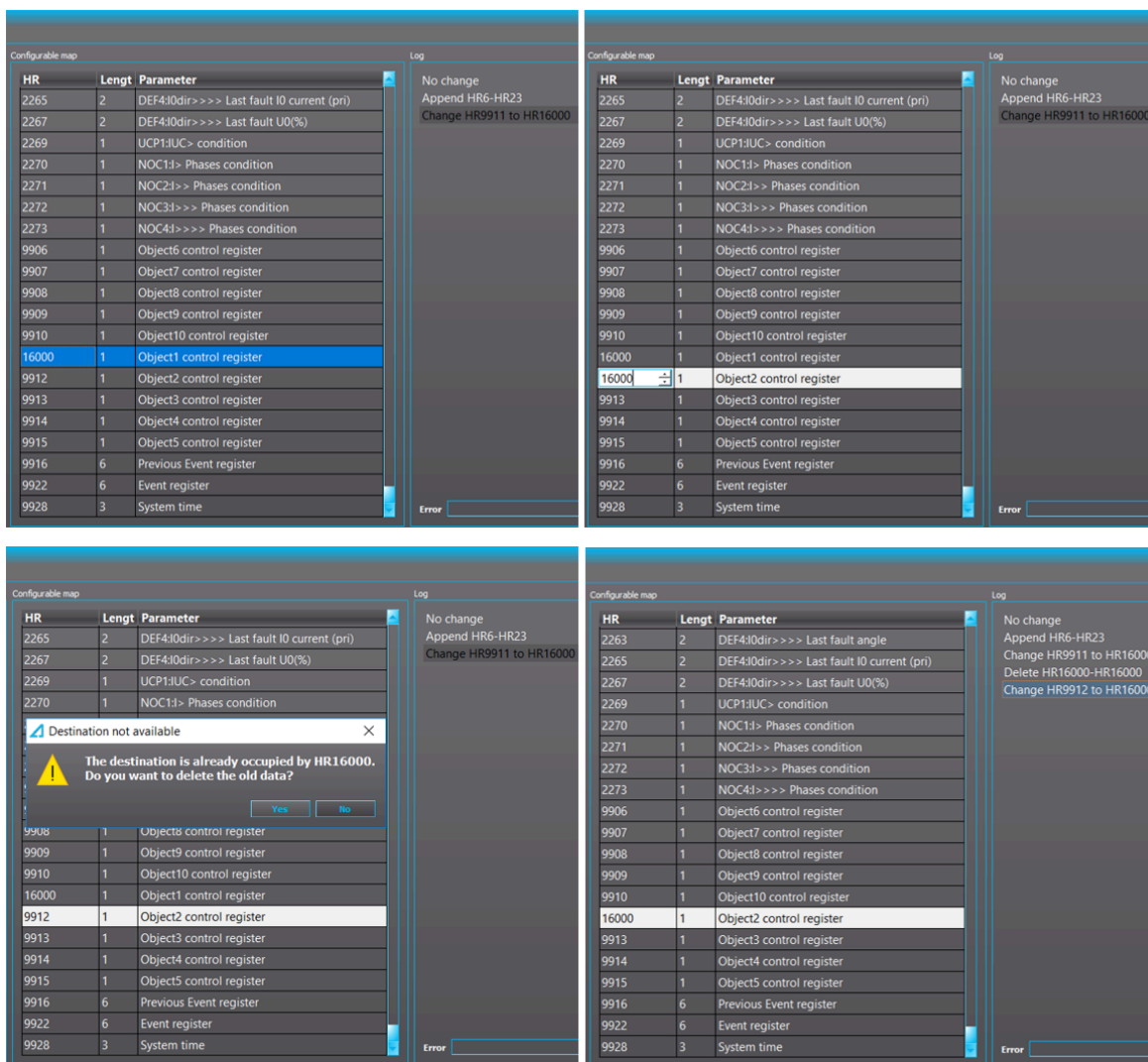

Fill HR

This function can be used to change all HRs of multiple consecutive parameters starting from the selected HR.

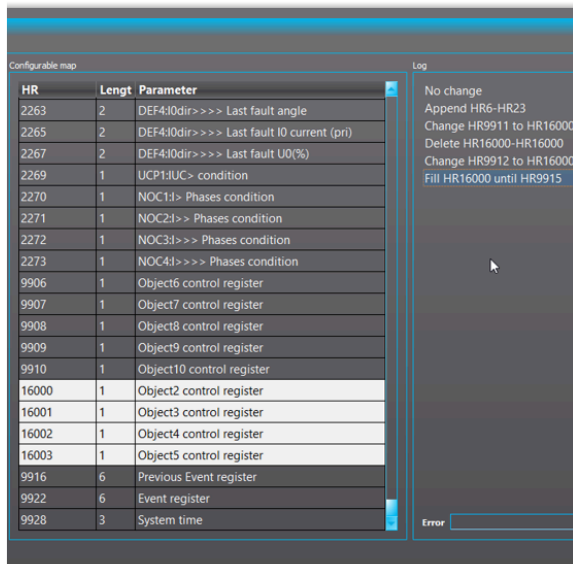
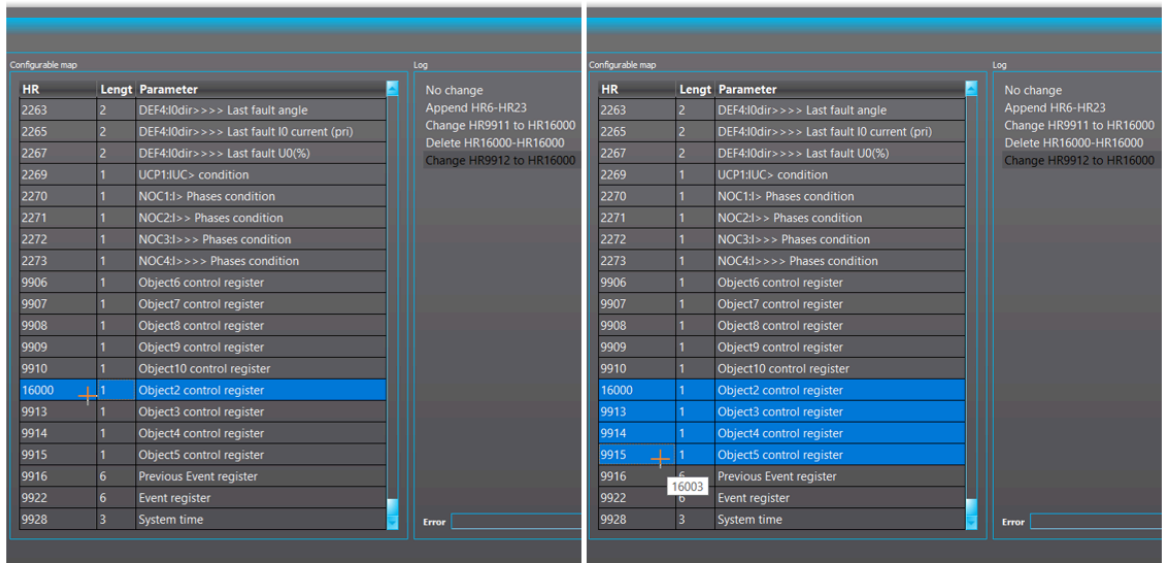

To fill, first you must select a row. The cursor becomes a cross cursor when moved near the bottom line of the selection area. While on the cursor, click and drag the mouse to where you want to fill to. While dragging, a tooltip text is shown containing the resulting HR after the fill. The fill is executed after you release the mouse.

Fill can be done in both directions, up and down.

Similar to when changing the HR value, if the destination of the fill is already occupied, the user is notified of the conflict and prompted to choose between deleting the occupied data or cancelling the fill.

Delete HR

HR(s) can simply be deleted by selecting the range to delete and clicking the "Delete" icon (the red X; see the image below) on the toolbar or press the **Delete** key on the keyboard.

The deletion applies to rows only. So, if the row order is HR5-HR10-HR7, deleting HR5-HR10 will not delete HR7.

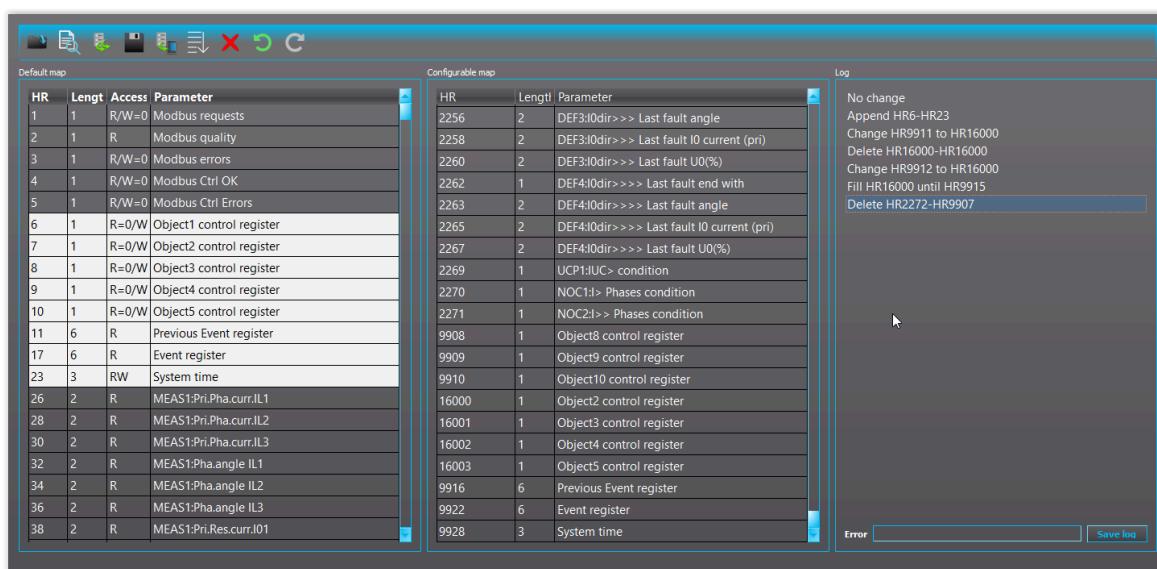
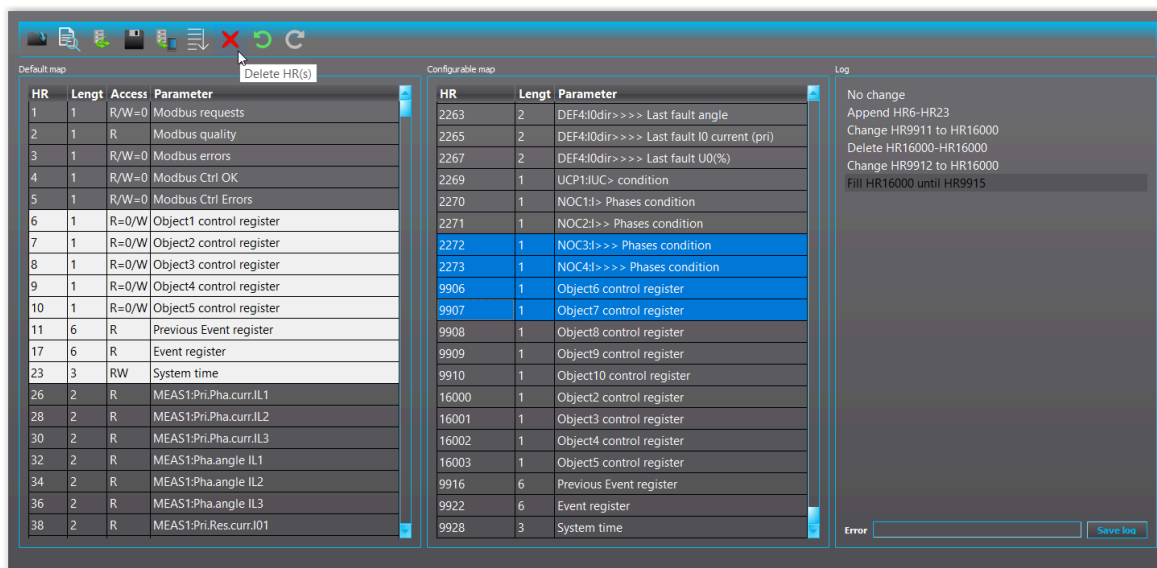

Change length

The length of data can be changed from "1" to "2" and vice versa. This can be done by double-clicking the row that needed to be changed in the configurable map. All the rows with HR greater than the selected row will have their HRs changed accordingly.

If two changes are made consecutively to a row (1 to 2 and back to 1), no log entry is created.

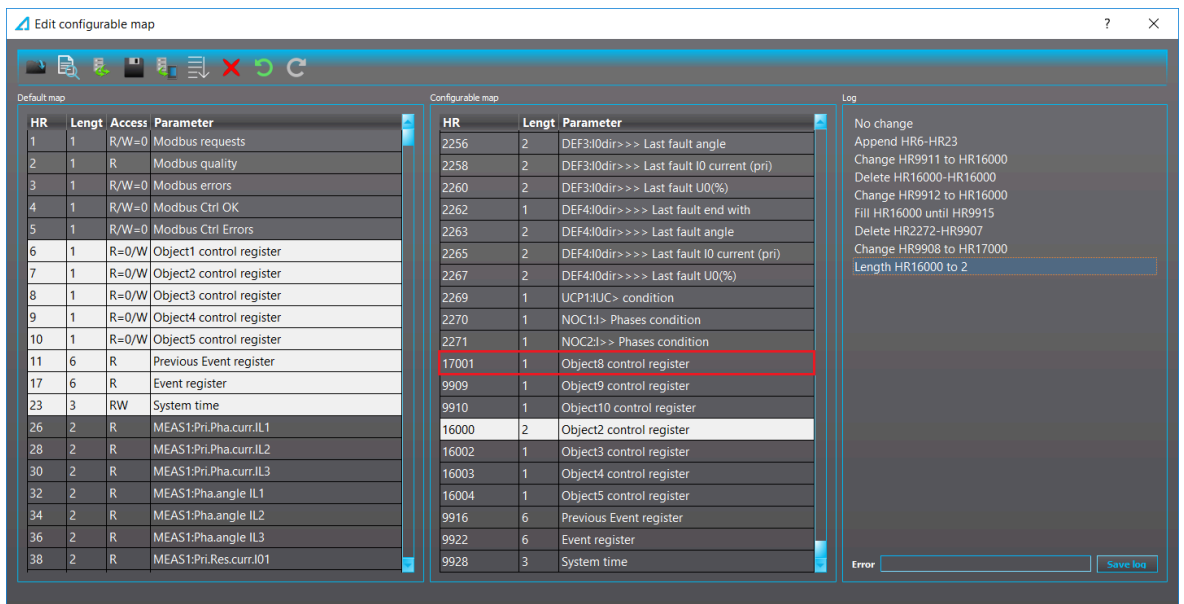
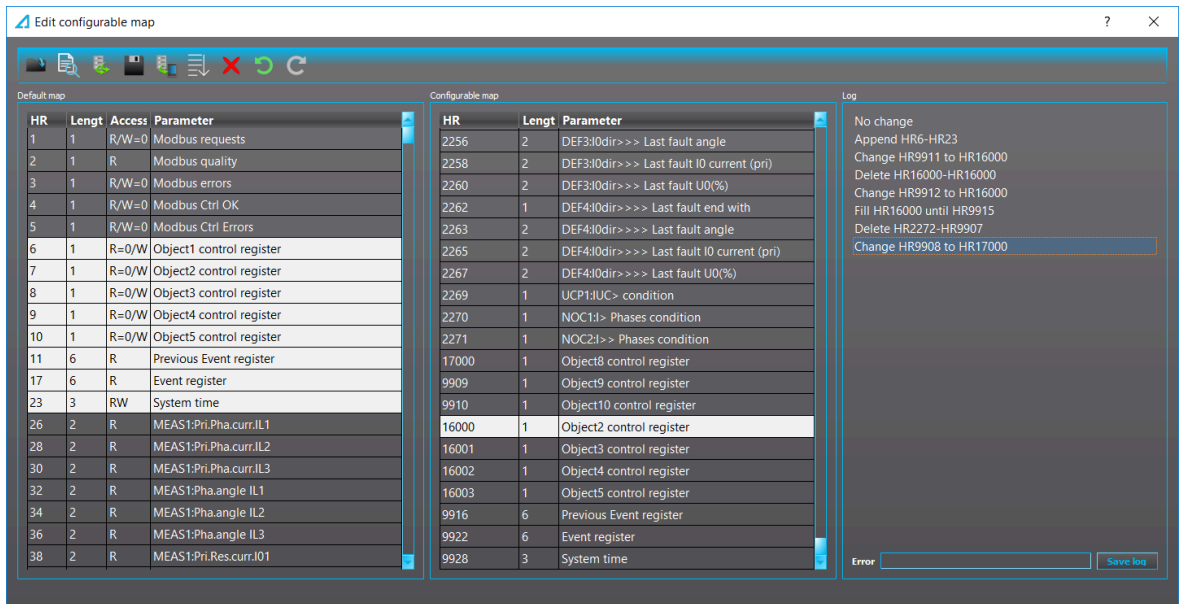

Sort by HR

The configurable map can be sorted by HR using the "Sort by HR" icon on the toolbar (see the image below). If the map is already sorted, no log entry is created.

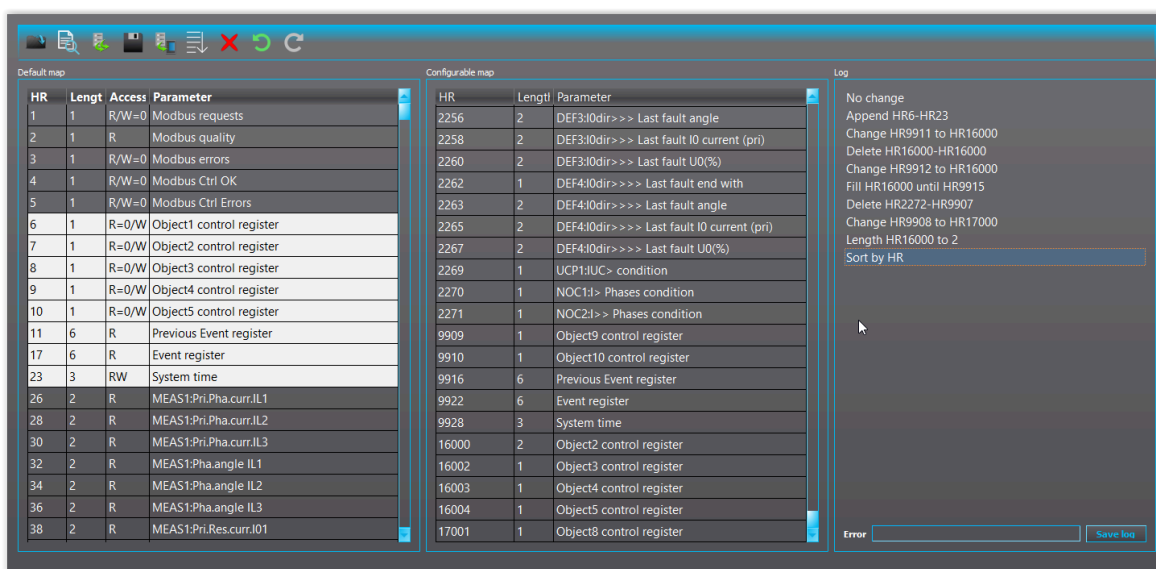
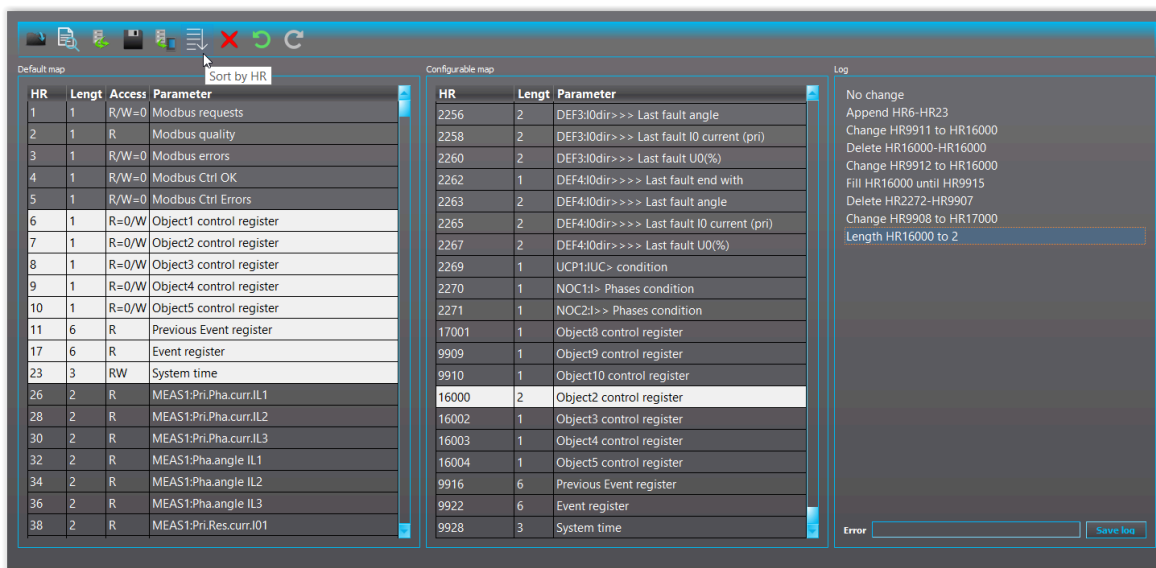

Preview

A preview of the map can be shown by clicking the "Preview" icon on the toolbar (see the image below).

HR	Old HR	Parameter	Access	Length
2260	2260	DEF3:I0dir>>> Last fault U0(%)	R	2
2262	2262	DEF4:I0dir>>>> Last fault end with	R	1
2263	2263	DEF4:I0dir>>>> Last fault angle	R	2
2265	2265	DEF4:I0dir>>>> Last fault I0 current (pri)	R	2
2267	2267	DEF4:I0dir>>>> Last fault U0(%)	R	2
2269	2269	UCP1:IUC> condition	R	1
2270	2270	NOC1:I> Phases condition	R	1
2271	2271	NOC2:I>> Phases condition	R	1
9909	9909	Object9 control register	R=0/W	1
9910	9910	Object10 control register	R=0/W	1
9916	11	Previous Event register	R	6
9922	17	Event register	R	6
9928	23	System time	RW	3
16000	7	Object2 control register	R=0/W	2
16002	8	Object3 control register	R=0/W	1
16003	9	Object4 control register	R=0/W	1
16004	10	Object5 control register	R=0/W	1
17001	9908	Object8 control register	R=0/W	1

Export map to text file

The preview map can be exported to a text file using the "Export" icon on the toolbar (see the image below).

```

1  HR  Old HR  Parameter  Access  Length
2
3  // many lines omitted
4
5  2262  2262  DEF4:I0dir>>>> Last fault end with R  1
6  2263  2263  DEF4:I0dir>>>> Last fault angle R  2
7  2265  2265  DEF4:I0dir>>>> Last fault I0 current (pri) R  2
8  2267  2267  DEF4:I0dir>>>> Last fault U0(%) R  2
9  2269  2269  UCP1:IUC> condition R  1
10 2270  2270  NOC1:I> Phases condition R  1
11 2271  2271  NOC2:I>> Phases condition R  1
12 9909  9909  Object9 control register R=0/W  1
13 9910  9910  Object10 control register R=0/W  1
14 9916  11  Previous Event register R  6
15 9922  17  Event register R  6
16 9928  23  System time RW  3
17 16000  7  Object2 control register R=0/W  2
18 16002  8  Object3 control register R=0/W  1
19 16003  9  Object4 control register R=0/W  1
20 16004  10  Object5 control register R=0/W  1
21 17001  9908  Object8 control register R=0/W  1

```

Undo/Redo

Changes made to the configuration map are displayed in the log section and can be undone and redone.

The Undo action can be executed in any of the following ways listed below:

- Using the key combination **Control + Z**.
- Clicking on the line in the log section.
- Clicking the "Undo" icon on the toolbar.

The Redo action can be executed in any of the following ways listed below:

- Using the key combination **Control + Y**.
- Clicking on the line in the log section.
- Clicking the Redo icon on the toolbar.

Save and write to the relay

The configuration is saved to the .aqs file after you click the "Save" icon on the toolbar.

You can send the configuration to the relay by clicking the "Send to relay" icon on the toolbar.

The configuration can also be sent from the AQtivate menu bar: choose *Commands* → *Write To Relay*, check the "Modbus cfg" box in the pop-up window's list and then click the "Write" button.

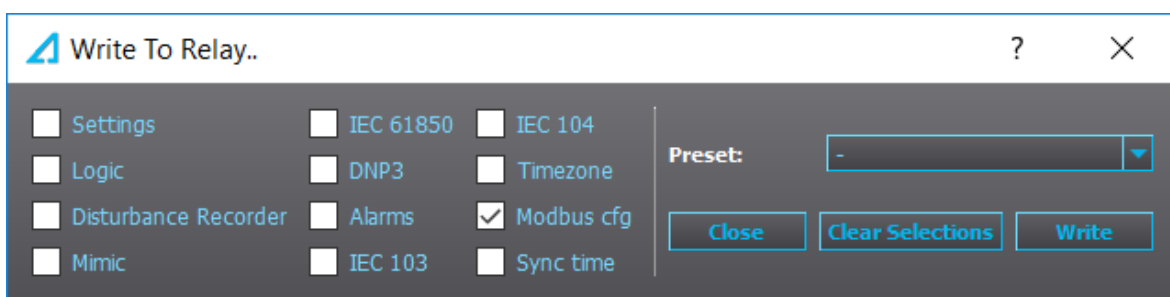

If no configuration file exists (e.g. the user may have forgotten to save it), there can be errors sending it to the relay.

After sending the configuration file, Modbus must be turned off and on again for the changes to apply.

7.10.4 SPA map

You can access the SPA-related information by opening the "SPA map" dialog from the *Tools* menu. The SPA map can be saved as a text file with the "Save" button (the floppy disk icon).

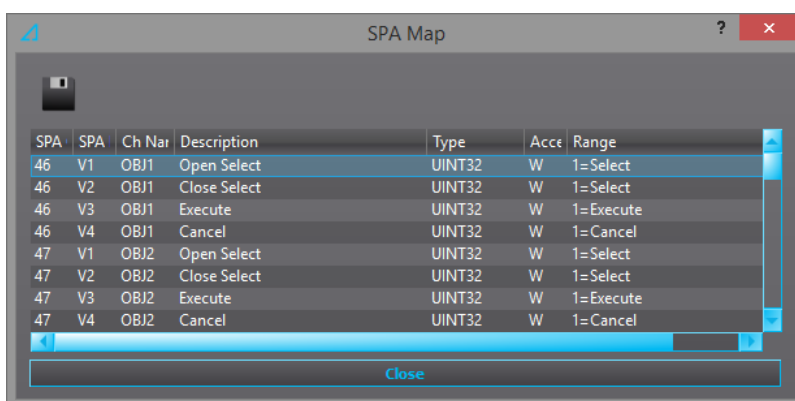

All SPA events can be found in *Tools* → *Events and registers* → *Event list*.

7.10.5 DNP

You can access the DNP-related information and settings by opening the "DNP" dialog from the *Tools* menu.

When the DNP map is ready, it can be saved as a text file by clicking the "DNP map" button (the earth flag icon) and then the "Save" button (the floppy disk icon). See the image below for further explanations of the DNP map's various icons.

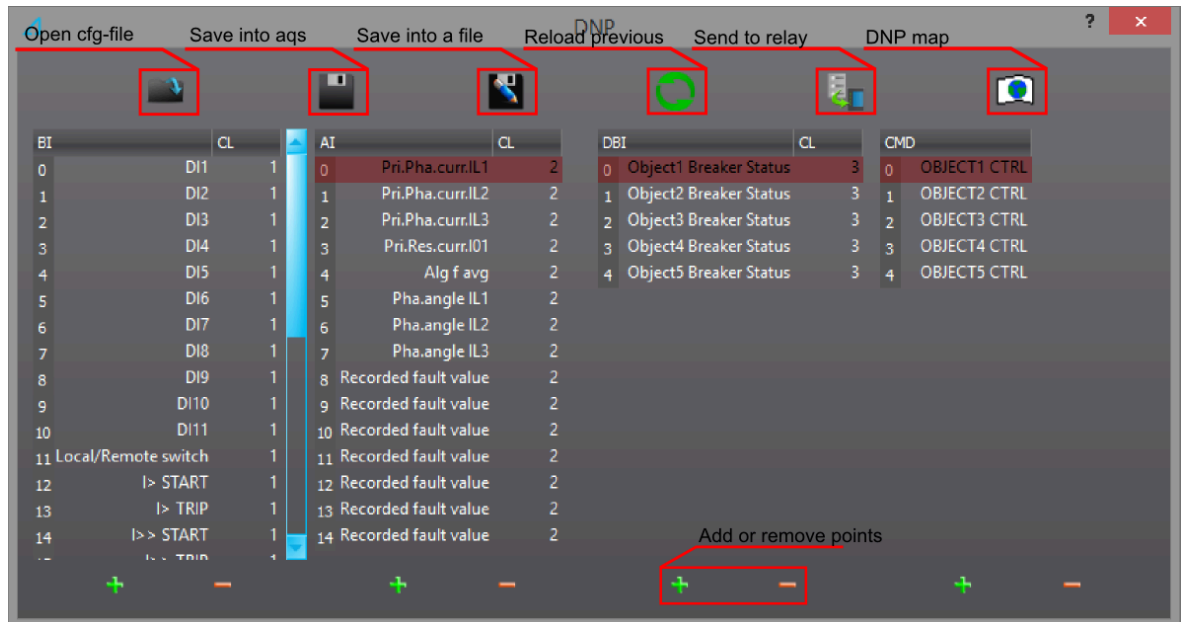

7.10.6 IEC 103



The IEC 103 map editor lists the addresses of the various signals. The user can set the General interrogation (GI) to 0 or 1.

7.10.7 IEC 101/104

Single points:			
IOA	GI	GI_Grou	Description
65537	0	0	Local/Remote switch
65538	0	0	DI1
65539	0	0	DI2

Double points:			
IOA	GI	GI_Grou	Description
196609	0	0	Object1 Breaker Status
196610	0	0	Object2 Breaker Status
196611	0	0	Object3 Breaker Status

Measured values:			
IOA	GI	GI_Grou	Description
851969	0	0	Pri.Pha.curr.L1
851970	0	0	Pha.angle IL1
851971	0	0	Pri.Pha.curr.L2

Intergrated Totals:			
IOA	CI	CI_Grou	Description
983041	0	0	Internal Relay Fault status
983042	0	0	Exp.Active Energy kWh
983043	0	0	Imp.Active Energy kWh

Single commands:	
IOA	Description
2949121	Reset Latches
2949122	Logical Input 1
2949123	Logical Input 2

Double commands:	
IOA	Description
3014657	OBJECT1 CTRL
3014658	OBJECT2 CTRL
3014659	OBJECT3 CTRL

The IEC 101/104 tool displays all signals available with the communication protocols. The user can define both the General interrogation (GI) and the GI groups for the signals.

7.10.8 Modbus Gateway

Modbus Gateway is a feature supported by AQ-S254 devices. It serves as a gateway, polling data from Modbus RTU slaves and Modbus TCP servers and making those data available to IEC 61850.

For simplicity, in this document, the Modbus RTU slaves and Modbus TCP servers will be referred to as RTU slaves and TCP slaves; and the data acquired from the slaves are called virtual inputs.

Configure Modbus Gateway

The configuration dialog for the gateway can be opened from AQtivate's menu bar under *Tools* → *Communication*.

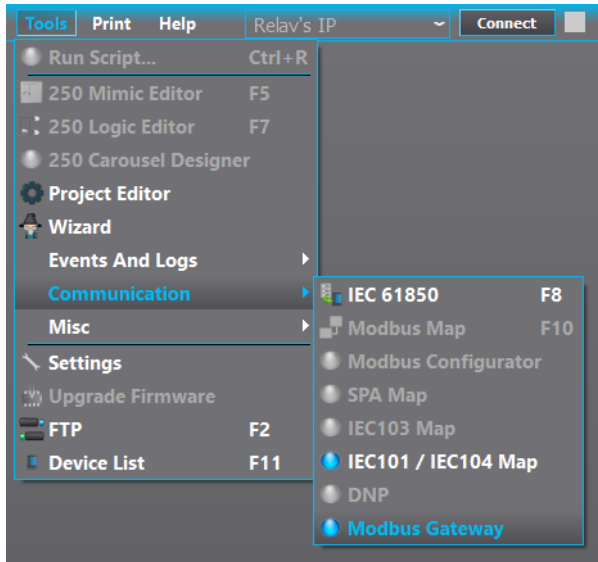

An empty configuration is shown below.

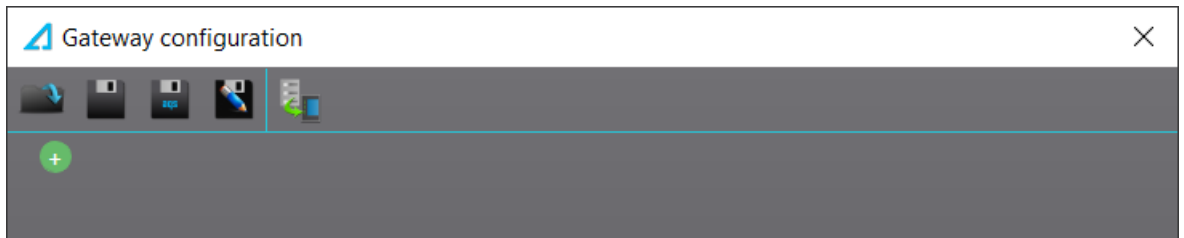

The toolbar of the dialog contains the following actions.

Action	Description
Open	Open an existing configuration file (.csv).
Save	Save the currently edited file.
Save to AQS	Save the configuration to the current AQS file. Only enabled when there is an AQS file opened in AQtivate.
Save as	Save the configuration as a csb-file.
Send to relay	Send the configuration to the relay.

Configure slave

A slave can be added by pressing the plus sign at the bottom of the slave list and can be deleted using the minus sign next to the slave's name. The maximum number of slaves is 16.

The configurations for an RTU slave and a TCP slave are shown below.

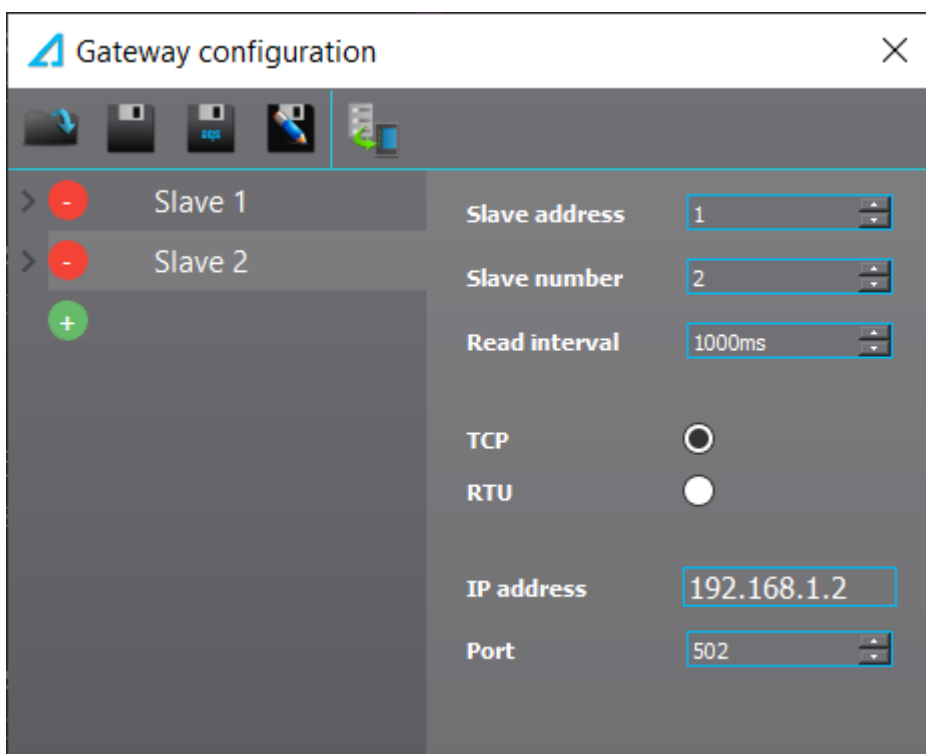
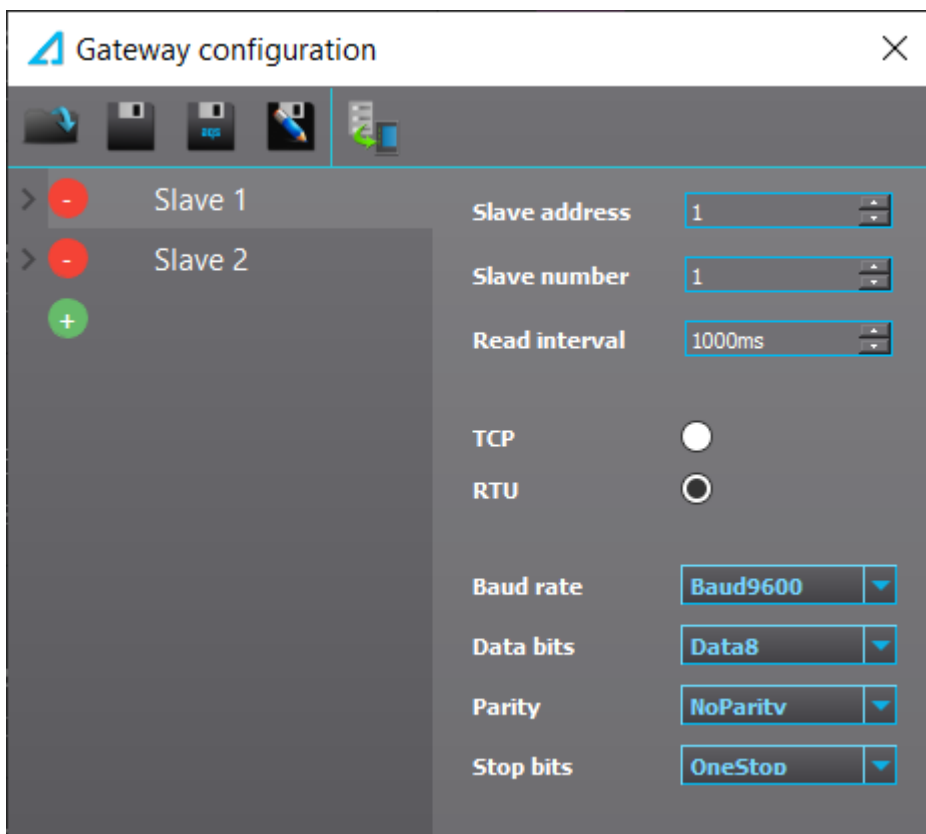

The description of the configurations can be found in the table below.

Common configuration	Value range	Description
Slave address	1 ... 247	Modbus slave address
Slave number	1 ... 16	Unique ID in gateway

Read interval	100ms ... 60000ms	Polling interval
RTU configuration	Value range	Description
Baud rate	1200 ... 115200	Baud rate
Data bits	7 ... 8	Data bits
Parity	0 ... 2	Parity bit(s)
Stop bits	1 ... 2	Stop bit(s)
TCP configuration	Value range	Description
IP	0.0.0.0 ... 255.255.255.255	IP address
Port	0 ... 65535	TCP port

Configure virtual input

The data acquired from the slaves are called virtual inputs, which can be categorized into five types.

Virtual input type	Underlying data type	Value range	Max count
Virtual bit	One bit	0 ... 1	128
Virtual double bit	Two bits	0 ... 3	32
Virtual counter	32-bit unsigned integer	0 ... 4,294,967,295	128
Virtual integer	32-bit signed integer	-2,147,483,648 ... 2,147,483,647	128
Virtual measurement	32-bit floating point value	$-3.4 \times 10^{38} \dots 3.4 \times 10^{38}$	128

All virtual inputs share the following configurations.

Common configuration	Value range	Description
Input / Holding registers	Input registers Holding registers	Modbus register type to be read.
Start data address	1 ... 65535	First Modbus register to be read.
Description	Max 31 characters	Optional. Description of the input.
Virtual input number	1 to max input number of the configured type	Unique input ID for the current type in gateway.

Configure virtual bit / double bit

The configurations for a virtual bit and a virtual double bit inputs are shown below.

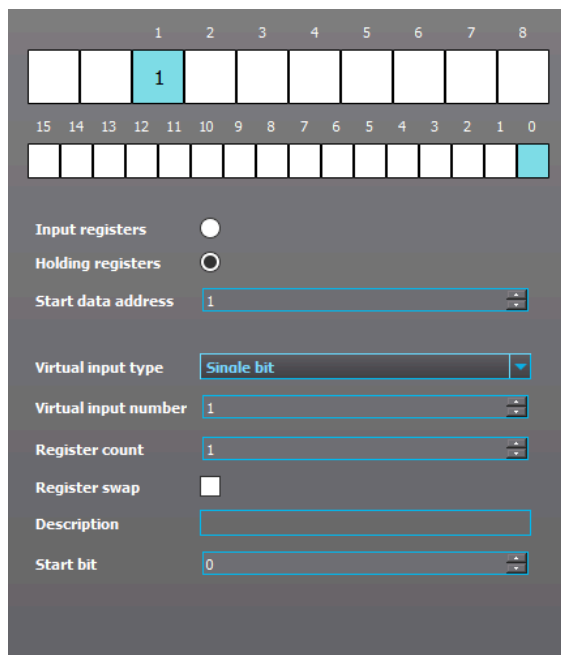
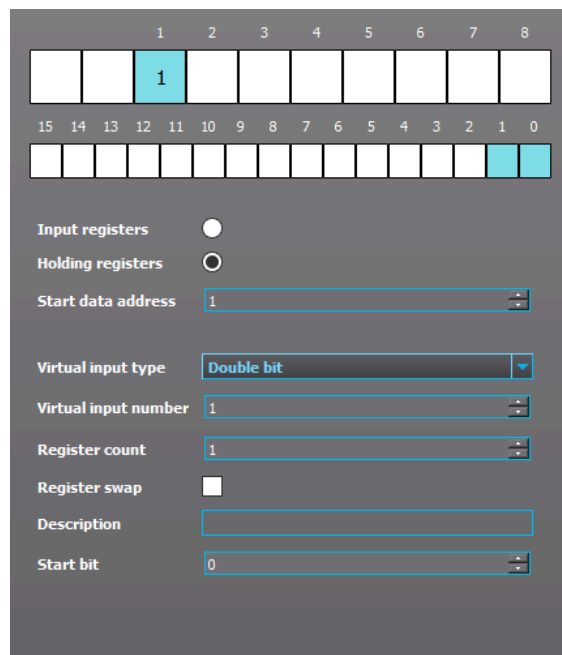



In addition to the common configuration, virtual bits and virtual double bit have the following configurations.

Configuration	Value range	Description
Register count	1	Number of registers to be read.
Start bit	0 ... 15 (virtual bit) 0 ... 14 (virtual double bit)	First bit in the register to be taken into account.

Configure virtual counter / integer

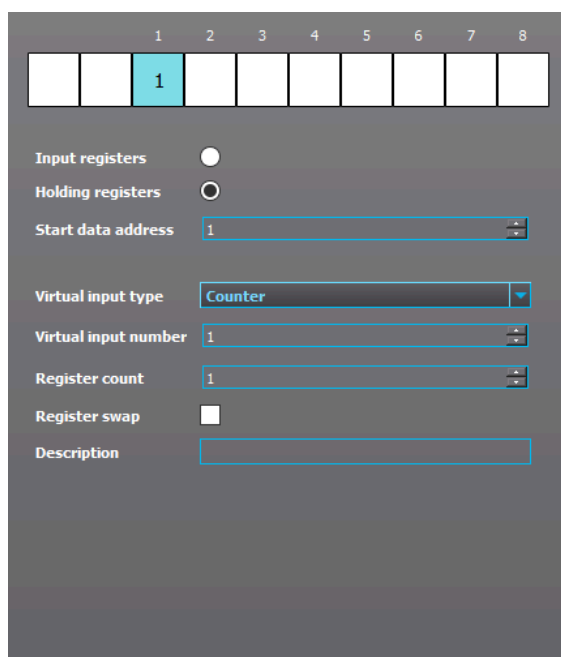
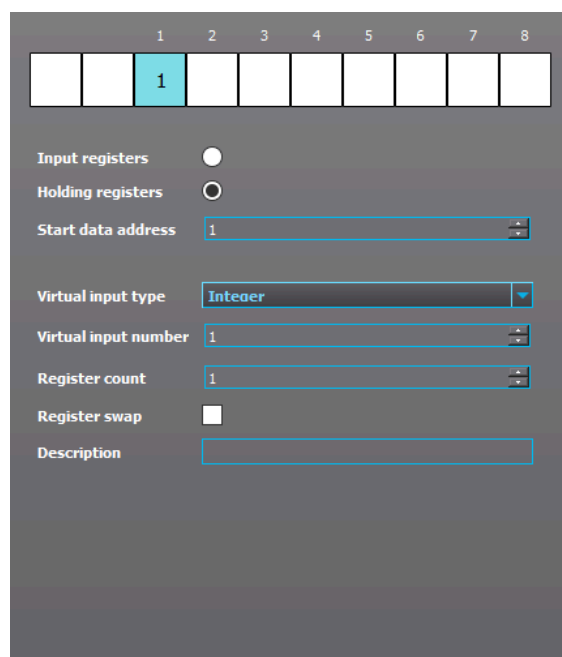
The configurations for a virtual counter and a virtual integer inputs are shown below.

In addition to the common configuration, virtual counter and virtual integer have the following configurations.

Configuration	Value range	Description
Register count	1 ... 2	Number of registers to be read.
Register swap	SWAP or NO SWAP	Swap the register order.

The register swap configuration is only taken into account when the register count is 2.

- Register swap disabled, the first register is the high register.
- Register swap enabled, the first register is the low register.

Configure virtual measurement

Modbus Gateway supports 2 ways of storing floating point values.

Table. 7.10.8 - 6. 32-bit floating-point value stored in 2 consecutive 16-bit registers. For example (no word swap)

Floating-point value	2.875
Hexadecimal value	0x4038 0000
1 st Modbus register	0x4038
2 nd Modbus register	0x0000

Table. 7.10.8 - 7. Scaled floating-point value stored in 1 ... 4 consecutive register(s) as integers. For example (no word swap, 2 registers)

Floating-point value	2.875
Scaling factor	1000
Scaled value	2875
Hexadecimal value	0x0000 0B3B
1 st Modbus register	0x0000
2 nd Modbus register	0x0B3B

If the value is stored using the first way, the input type should be configured to "Measurement". Otherwise, the input type should be configured to "Measurement (converted)" as shown below.

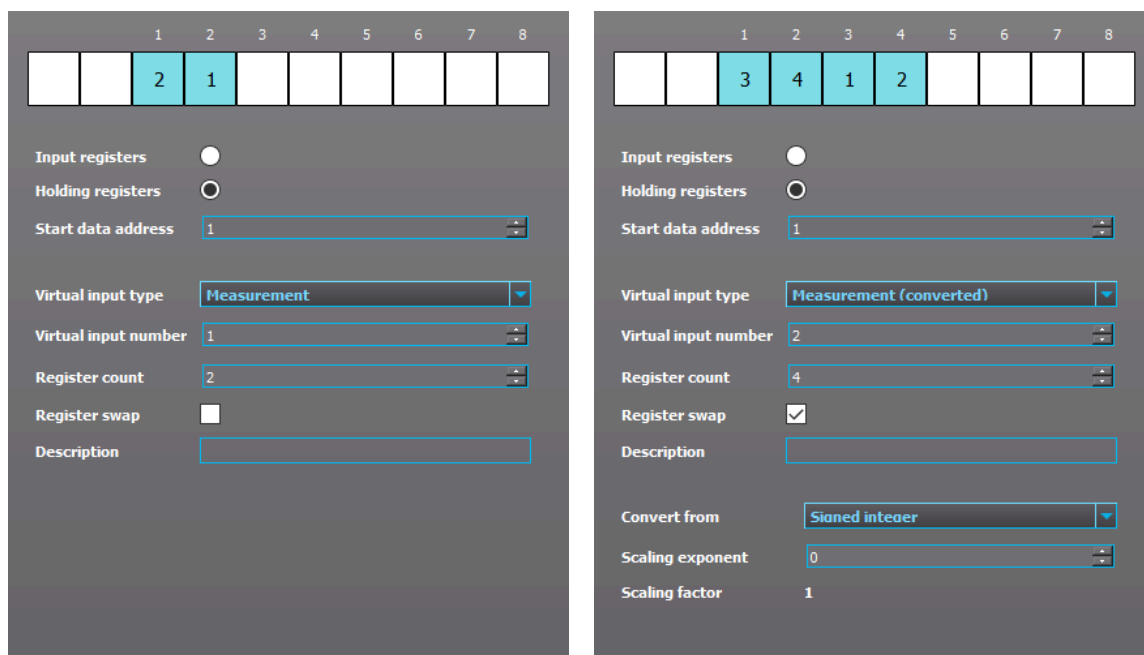

In addition to the common configuration, virtual measurement has the following configurations.

Configuration	Value range	Description
Register count	2	Number of registers to be read.
Register swap	SWAP or NO SWAP	Swap the register order.

The register swap configuration is only taken into account when the register count is 2.

Table. 7.10.8 - 8. Example where register swap is disabled, the first register is the high register

Floating-point value	2.875
Hexadecimal value	0x4038 0000
1 st Modbus register	0x4038
2 nd Modbus register	0x0000

Table. 7.10.8 - 9. Example where register swap is enabled, the first register is the low register

Floating-point value	2.875
Hexadecimal value	0x4038 0000
1 st Modbus register	0x0000
2 nd Modbus register	0x4038

In addition to the common configuration, virtual measurement (converted) has the following configurations.

Configuration	Value range	Description
Register count	1 ... 4	Number of registers to be read.
Register swap	SWAP or NO SWAP	Swap the register order.
Convert from	Signed integer Unsigned integer	Treat the Modbus register as signed or unsigned before converting to float.

Scaling exponent	-3 ... 3	Scaling factor = 10 ^{scaling exponent} (-1000 ... 1000)
------------------	----------	---------------------------------------------------------------------

Table. 7.10.8 - 10. The register swap configuration is only taken into account when the register count is greater than 2.

Register count 2 (for example 111 – 112)	
Not swap order (high to low)	111 – 112
Swap order (high to low)	112 – 111
Register count 3 (for example 111 – 113)	
Not swap order (high to low)	111 – 112 – 113
Swap order (high to low)	113 – 112 – 111
Register count 4 (for example 111 – 114)	
Not swap order (high to low)	111 – 112 – 113 – 114
Swap order (high to low)	112 – 111 – 114 – 113

Running Modbus Gateway

After saving the configuration file and sending it to the relay, the gateway can be started using the “MB Gateway” tab on the left side of AQtivate’s main window.

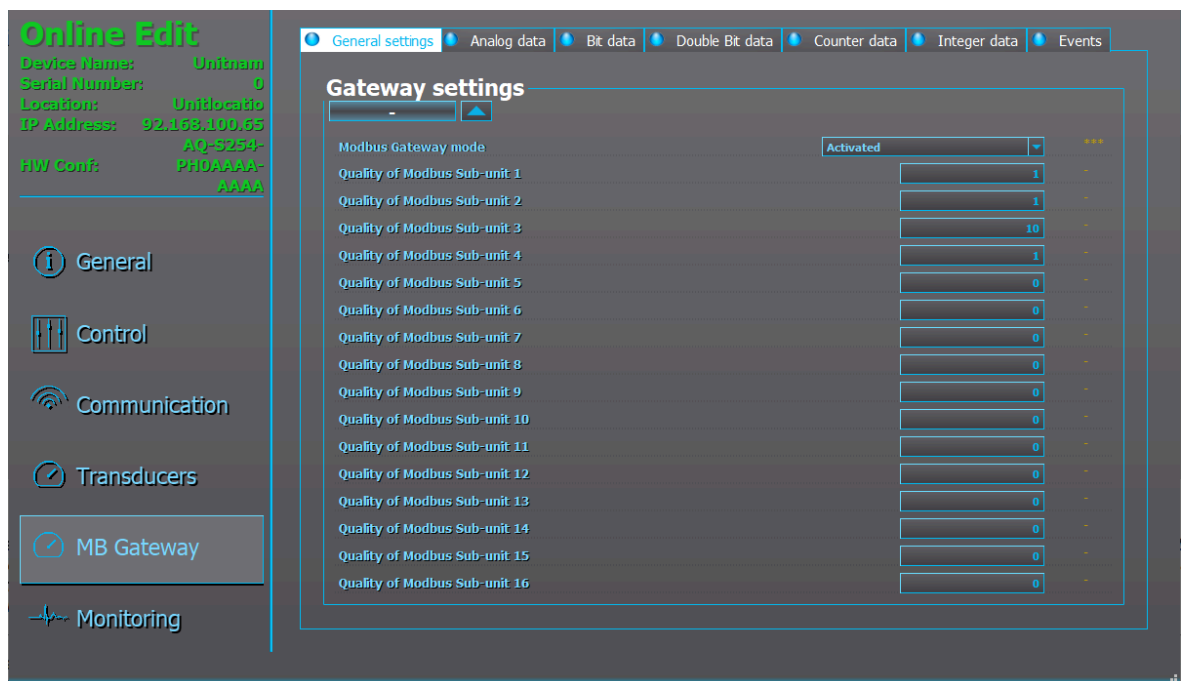

In the general setting tab, the quality of the slaves can also be seen (Live Edit required). The acquired data can be seen from the corresponding tab (Live Edit required).

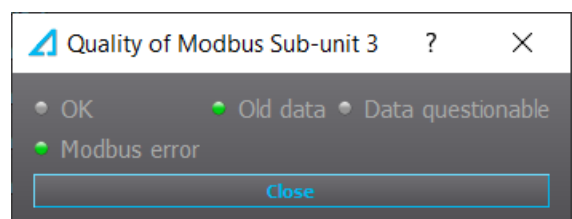
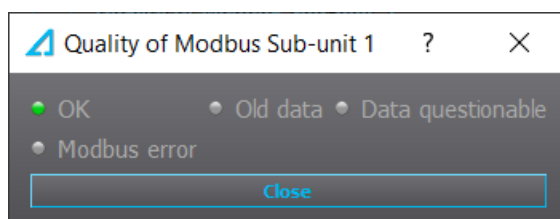

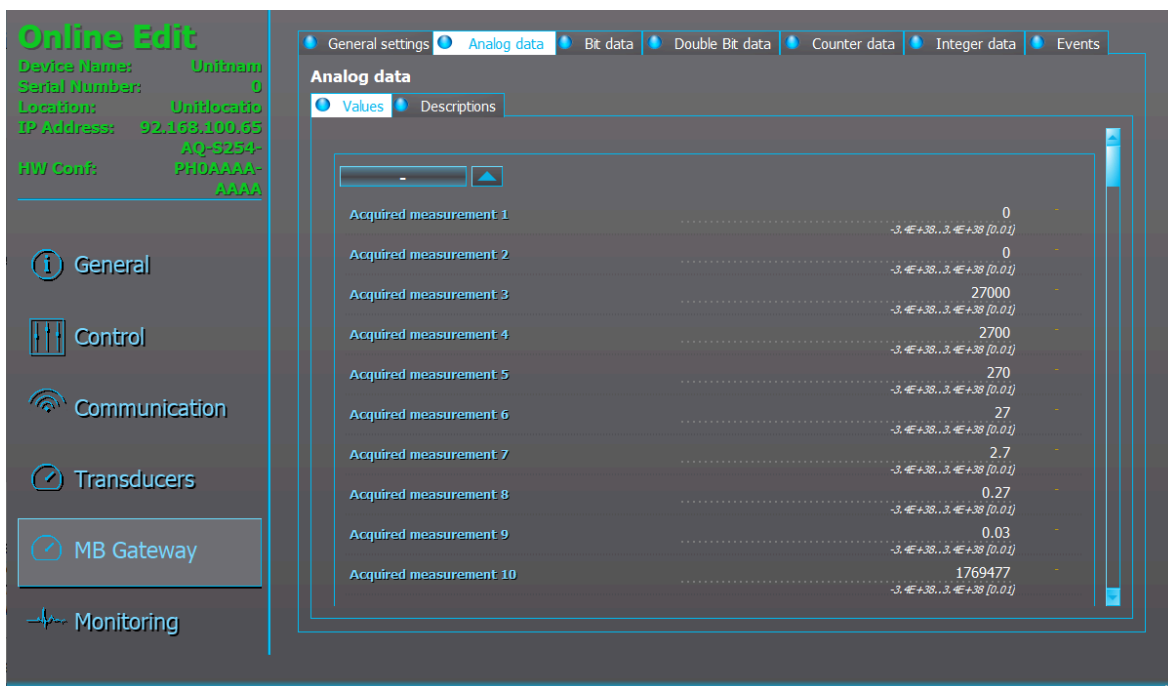

Getting data from IEC 61850

In IEC 61850, the acquired data are stored in 5 logical nodes corresponding to 5 virtual input types.

Virtual input type	Logical node prefix	Logical node class	Logical node instance
Virtual bit	GWBIT	GGIO	1
Virtual double bit	GWDBIT	GGIO	1
Virtual counter	GWCNT	GGIO	1
Virtual integer	GWINT	GGIO	1
Virtual measurement	GWMEAS	GGIO	1

7.11 Miscellaneous tools

Miscellaneous tools that are used less often. Usually tools for very specific purposes.

7.11.1 Find signal usage

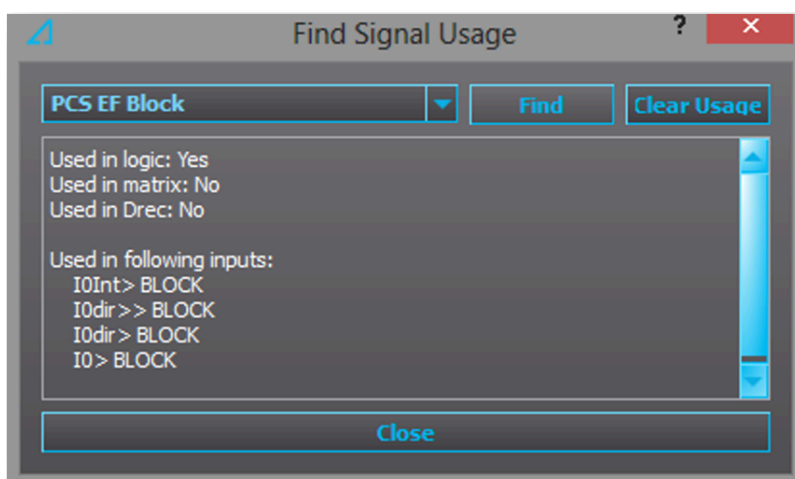

With the help of the "Find signal usage" tool you can see where a signal has been connected to in the configuration.

In the example picture above, the programmable control switch "PCS EF Block" has been chosen. When the "Find" button is clicked, AQtivate displays a list of places where the chosen signal has been used. In this case this PCS button can block four earth fault functions. AQtivate also displays whether or not the signal has been used in logic, matrix, and the disturbance recorder. Pressing the "Clear usage" button erases all of the connections listed. The logic must be written into the relay to use any changes made to the listed connections.

NOTE!



When you clear a signal that has been used in a logic, you are advised to check that the logic is still intact.

7.11.2 Measurement recorder

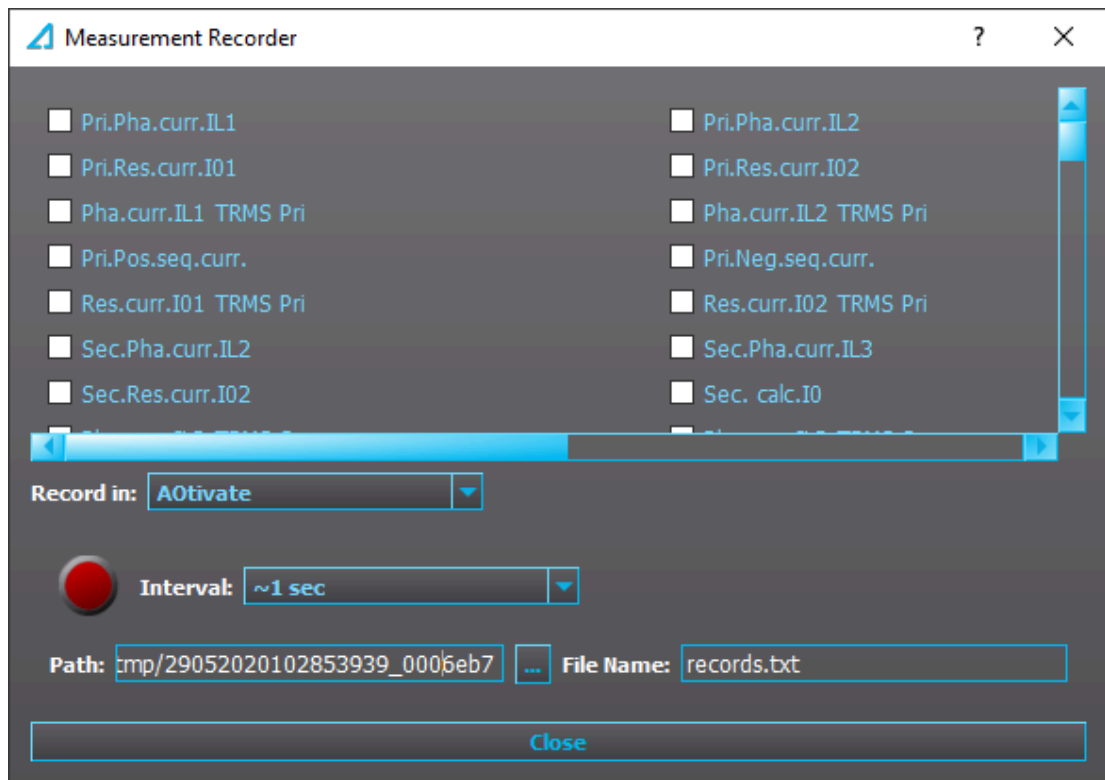

Specific measurements can be recorded as a text file by using the measurement recorder. In the "Measurement recorder" dialog, you can select the measurements you want to be recorded by checking their respective check boxes. Please note that activating the measurement recorder requires that there is a connection to a relay and that the Live Edit mode is enabled. The recording interval can be changed from the drop-down menu of the "Interval" box (next to the big red circle).

With the "Record in" selection (located right below the check boxes) you can choose whether the measurements are recorded in AQtivate or in the relay itself. If you select "Relay", you only need to set the recording interval (from which AQtivate estimates the maximum recording time) and then start recording by pressing the red "Record" button. The measurements recorded into a relay can then be seen by connecting to the relay with AQtivate PRO software. If you select "AQtivate", both the AQtivate software and the Live Edit mode need to be activated. The record file location can be changed by editing the "Path" field. You can also change the file name in the "File name" field. Recording starts when you hit the red "Record" button. You can stop the recording by hitting the blue "Stop" button.



WARNING!

Closing the "Measurement recorder" dialog does not stop the recording!

7.11.3 Aqs generator

With the Aqs generator you can generate .aqs files without having a relay to download configuration files from. You only need a firmware package to generate a configuration file. When generating a file you have to choose the firmware package, the destination (includes the name for the .aqs package) and the device type (see the example image above).

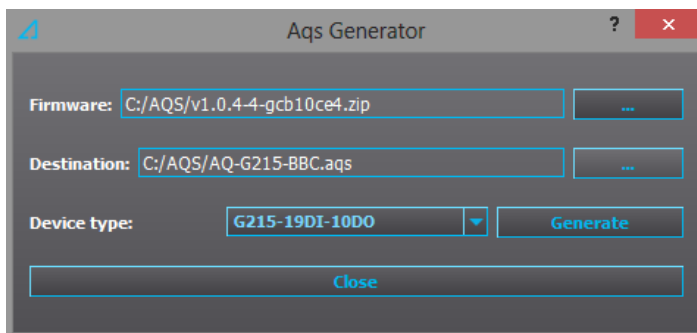

The generated file can be used for studying and other similar purposes. It is otherwise similar to a file downloaded from a relay, except it does not have a serial number nor does it display its hardware and software configurations in the *General* menu. You can upload the generated configuration to any relay with the same hardware configuration. Please note that AQtivate may warn about missing mimics, logic and disturbance recorder if these are not in the configuration.

Please note that when selecting the device type, you can only choose a hardware configuration with digital inputs, digital outputs and/or an arc protection card. Other types of option cards are not supported by the Aqs generator.

7.11.4 Compare files

You can compare .aqs files with the "Compare files" dialog. You can select one .aqs file for "Open file 1" and another for "Open file 2", and AQtivate checks for differences in these two files. The basic value differences are shown in the top half of the list. The latter half shows if there are any differences in the logic, mimic or disturbance recorder files.

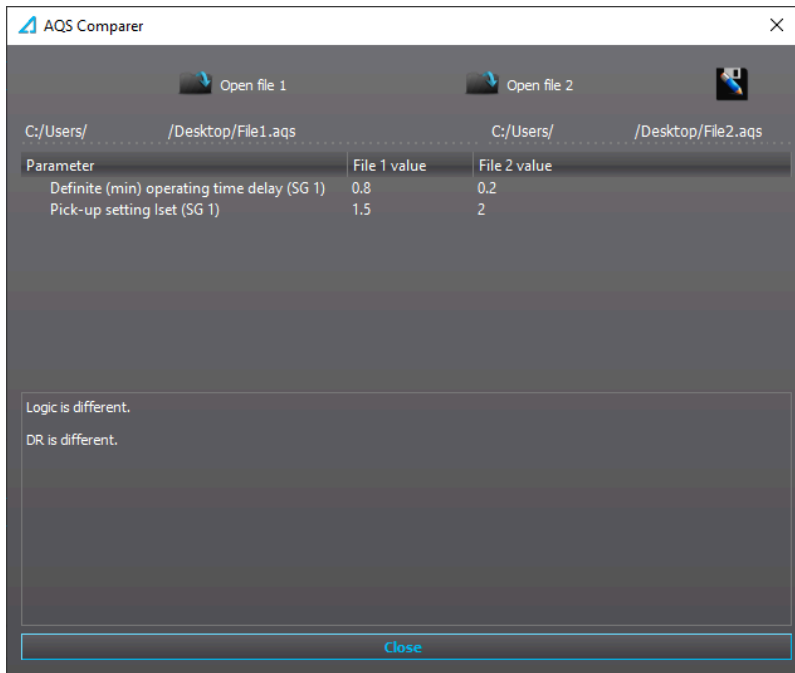

7.11.5 Copy SG settings

You can copy the setting group (SG) settings from one setting group to another setting group with the "Copy SG settings" dialog. This is useful if the settings are very similar between the setting groups in use.

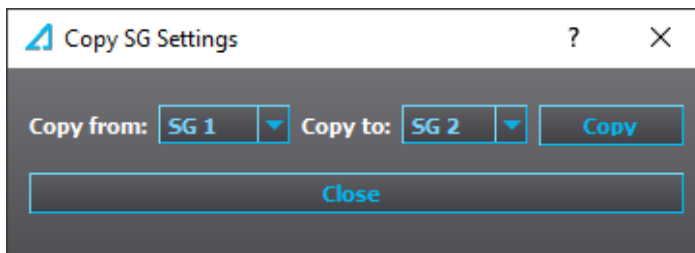

7.11.6 Calibrations

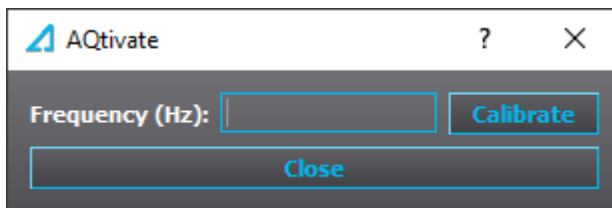

Used for manually calibrating the accuracy of the frequency measurement. AQ-200 units are always delivered with the frequency measurements calibrated.

WARNING!



The calibration of the frequency measurement should only be done by a qualified person who has been instructed how to do this.

7.11.7 Clear matrix

Clears the matrix portion of a logic file. Affects the connections made at *Control* → *Device I/O* → *Device I/O matrix*. After clearing the matrix the changes take effect only after loading the logic at the main toolbar (*Commands* → *Write to relay*).

7.11.8 Rear panel

The "Rear panel" dialog shows the content of the relay's back panel. What you see here depends on the .aq5 file that is currently open.

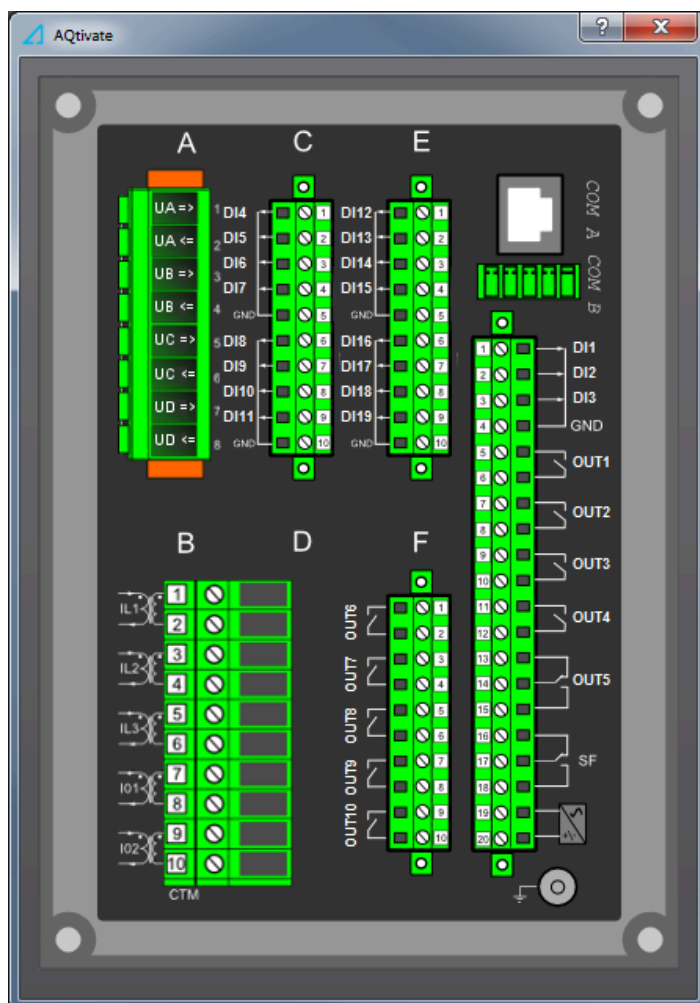

7.11.9 DI configurator

With the "DI configurator" tool you can adjust the input activation and release thresholds as well as activation and release delay times. They can be adjusted to multiple or all inputs at once, which lets you avoid typing the same setting to each input individually.

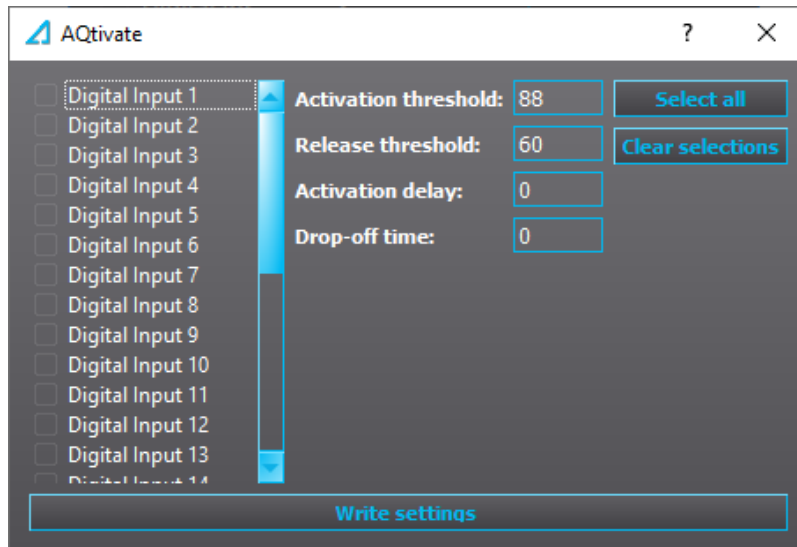

7.11.10 GC-30 configurator

The "GC-30 configurator" is used in Generator Commander applications to write and read values from the excitation unit.



7.12 FTP

You can open the FTP client by selecting *Tools* from the AQtivate main toolbar and then selecting "FTP" from the drop-down menu. This opens a dialog that contains two views. The one on the left lists local directories. The one on the right lists server directories. You can connect to the relay's FTP server by typing in the relay's IP address in the "FTP server" field and then clicking the "Connect" button (see the image below).

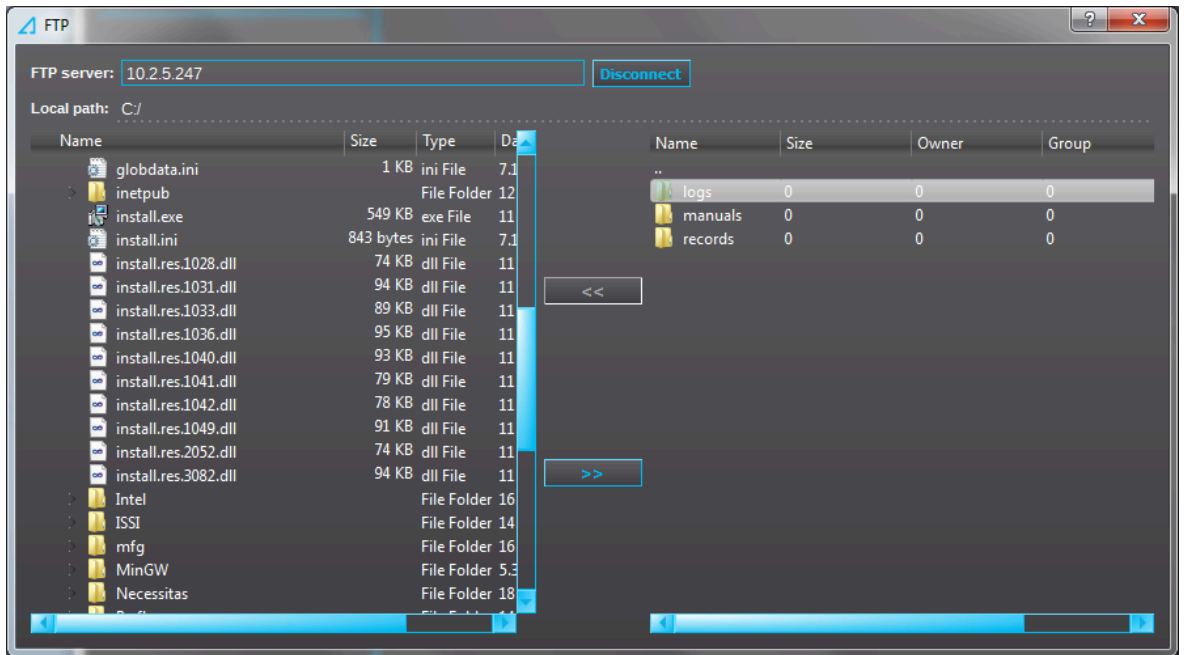

You can upload files to the server by selecting a file from one of the local directories and then pressing the ">>" button. To download a file, select a file from one of the server directories and then press the "<<" button. The file is then downloaded to the current selected local directory, which can be seen in the "Local path" field.

7.13 Device list

The "Device list" dialog lists all the available devices connected to the same network as your computer. You can connect to the selected device by double-clicking it on the list, or by selecting the device from the list and then clicking the "Connect" button. Note that establishing a connection closes this dialog. If new devices were connected to the network while viewing the device list, press the "Refresh" button (the green arrows icon) to make the new devices appear on the list.

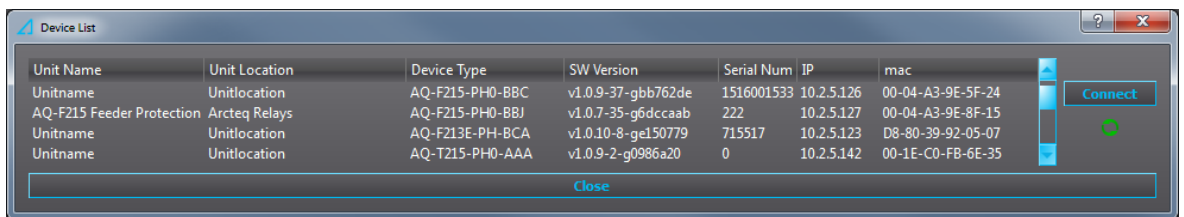

NOTE!

Some switches and firewalls may prevent AQtivate from getting this list.



NOTE!

The device list is not able to list the available devices, if more than one instance of AQtivate is open at the same time.

8 Exporting and importing settings in a .txt file

You can export all parameters as well as the matrix and logic settings into a single .txt file. It can then be edited in Excel or other spreadsheet software and imported back into an .aq5 file. You can do this with "Export settings" and "Import settings" that can be found under the *File* menu in AQtivate's main toolbar.

Table. 8 - 11. Snippet of exported setting file parameters with I> (overcurrent) settings. Values in "Values" column are editable.

#Id	Name	Value	Unit	Min	Max	Step	Description
24029	NOC1_DT_SET_1	1.160000	s	0.000	1800.000	0.005	Definite (min) operating time delay
24030	NOC1_DT_SET_2	1.160000	s	0.000	1800.000	0.005	Definite (min) operating time delay
24031	NOC1_DT_SET_3	1.160000	s	0.000	1800.000	0.005	Definite (min) operating time delay
24032	NOC1_DT_SET_4	0.040000	s	0.000	1800.000	0.005	Definite (min) operating time delay
24033	NOC1_DT_SET_5	0.040000	s	0.000	1800.000	0.005	Definite (min) operating time delay
24034	NOC1_DT_SET_6	0.040000	s	0.000	1800.000	0.005	Definite (min) operating time delay
24035	NOC1_DT_SET_7	0.040000	s	0.000	1800.000	0.005	Definite (min) operating time delay
24036	NOC1_DT_SET_8	0.040000	s	0.000	1800.000	0.005	Definite (min) operating time delay
24037	NOC1_DT_SET_P	0.040000	s	0.000	1800.000	0.005	Definite (min) operating time delay
24038	NOC1_EVENTMASKHI	0		0	4,29E+09	1	EventMaskHi
24039	NOC1_EVENTMASKLO	262095		0	4,29E+09	1	EventMaskLo
24041	NOC1_HARMBLK_1	0		0	1	1	Inrush Harmonic Blocking (Internal Only Trip)
24042	NOC1_HARMBLK_2	0		0	1	1	Inrush Harmonic Blocking (Internal Only Trip)
24043	NOC1_HARMBLK_3	0		0	1	1	Inrush Harmonic Blocking (Internal Only Trip)
24044	NOC1_HARMBLK_4	0		0	1	1	Inrush Harmonic Blocking (Internal Only Trip)
24045	NOC1_HARMBLK_5	0		0	1	1	Inrush Harmonic Blocking (Internal Only Trip)
24046	NOC1_HARMBLK_6	0		0	1	1	Inrush Harmonic Blocking (Internal Only Trip)
24047	NOC1_HARMBLK_7	0		0	1	1	Inrush Harmonic Blocking (Internal Only Trip)
24048	NOC1_HARMBLK_8	0		0	1	1	Inrush Harmonic Blocking (Internal Only Trip)

Table. 8 - 12. Snippet of exported setting file parameters with matrix, logic and block connections.

#Logic		
#Output	Type	Input1
#Matrix script:		
RELE_T1	CONNECT	OBJ1_OPENSIGNAL
RELE_T2	CONNECT	OBJ1_CLOSESIGNAL

RELE_T1	CONNECT	NOC1_TRIP
RELE_T1	CONNECT	NOC2_TRIP
RELE_T9	CONNECT	CBF1_CBFPACT
RELE_T8	CONNECT	CBF1_CBFPACT
RELE_T10	CONNECT	OV1_TRIP
LED_START	CONNECT	OV1_START
LED_TRIP	LATCH	OV1_TRIP
LED_TRIP	LATCH	CBF1_CBFPACT
LED_TRIP	LATCH	NOC1_TRIP

Table. 8 - 13. Snippet of exported setting file parameters with logic details.

#Logic details	
#Gate pos x	Gate pos y
0	190
0	490
50	340
100	410
100	510
110	660
110	730
140	40
140	130
150	210
230	350
240	710

9 Print menu

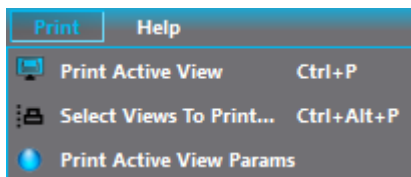

You can print out .aq5 configurations as PDF files with the *Print* menu.

"Print active view" prints out the view that is currently open as a PDF. However, if you need more than one view of the .aq5 file, you can click "Select views to print" and pick which views you want printed out. The first selection only shows the main menus. If you need everything under a menu printed, check its box (see the image below) and click "Print".

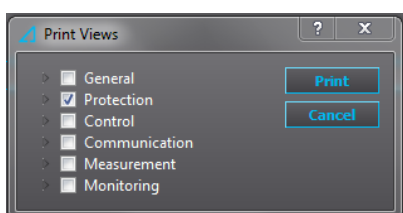

If you do not need entire menus but rather one or more specific subsections within the menus, you can expand them by clicking the gray arrow next to the check boxes. The image below (on the left) presents an example where the user wants to print only the setting view of the I> (overcurrent) function's first stage. The image below (on the right) shows what that print looks like in its PDF form.

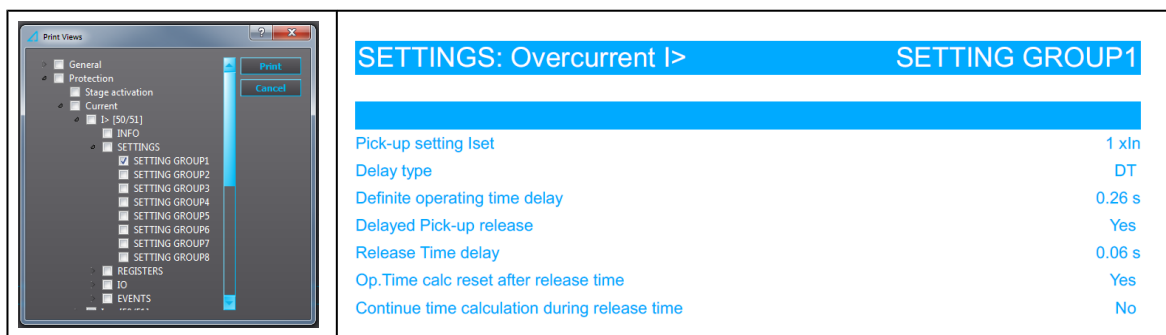

10 Updating firmware

First, please check that you have the firmware file available for the update. The firmware file is always labelled in a specific style and looks something like this: v1.0.1-97-g14e806f.zip. The firmware file appears to be a .zip file but **DO NOT UNZIP** this file before updating, as the AQtivate setting and configuration tool does this automatically when it is required.

Connecting to a relay

Connect to the relay. Connect the cable between the relay's back panel port and the PC. If your relay is in a network, connect your PC with the corresponding IP settings to the hub.



NOTE!

Only the relay's back Ethernet port can be used to update the firmware!

Open the AQtivate setting tool and search for the relay from *Tools* → *Device List* (the default shortcut key is F11). The software shows a list with the current firmware of the devices ("SW version"). If you are updating multiple relays in the network, please note that the "Device list" will display all the relays in the same list, both those that have already been updated and those that have not.

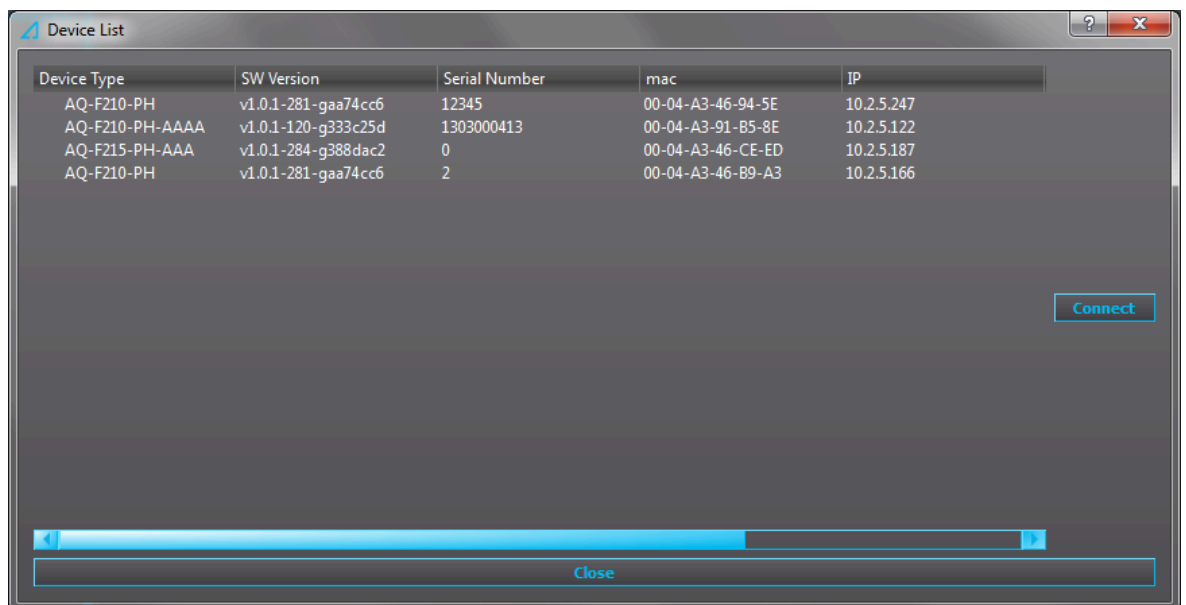

NOTE!



You can only update the firmware when when you have no .aqs configuration file open. If an .aqs file is open, you can close it at *File* → *Close*.

Updating the firmware

First, select "Upgrade firmware" from the *Tools* menu. This opens an update window (see the image below).

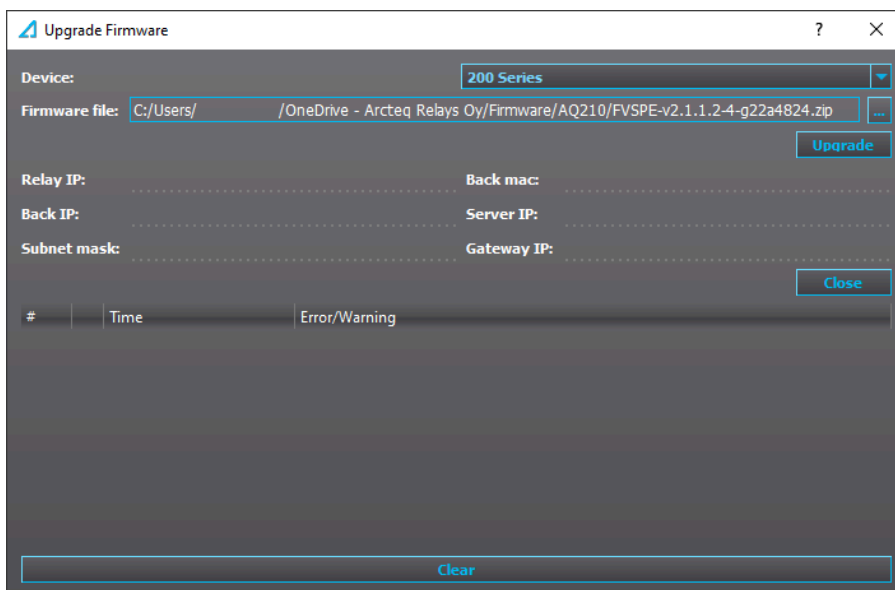

Add the firmware package into the "Firmware file" field by locating it with the "." button at the top right. Select the firmware zip file and click "Open". Next, click "Upgrade" and the firmware starts updating (see the image below).

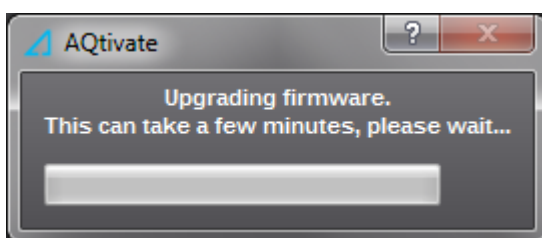

While AQtivate and the relay work on the firmware update, the relay will reboot several times and show a black and/or distorted display; this is normal. At some point AQtivate will also inform that the connection was closed; this is also normal. During the firmware update the window's info tags are filled with the information from the relay being updated (see the image below, on the left). When the update process is finished, the window's tags go blank once again (see the image below, on the right).

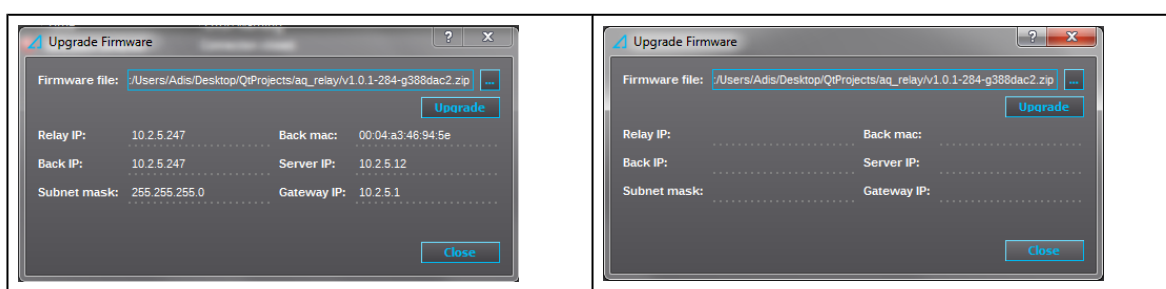

The "Warnings and errors" window shows when the firmware update is complete ("Firmware upgrade complete") (see the image below).

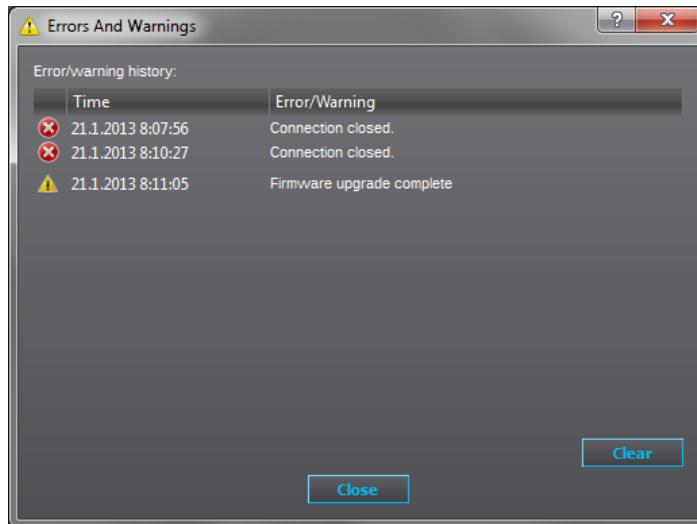

After the update is finished, the relay's display should be back to looking normal. The last reboot of the relay may take longer than what AQtivate estimates, so please be patient and give the relay approximately a minute to restart.

Troubleshooting the update process

Sometimes the firmware update fails. If this happens, you get a "Firmware upgrade failed" message instead of the normal "Firmware upgrade complete" message. The most common cause for update failures is that an anti-virus or firewall software interferes with the update process. In order to avoid this, we recommend disabling any anti-virus and firewall softwares for the duration of the update process. VPN softwares can also cause trouble with the firmware update, so we recommend disabling that as well.

11 Viewing disturbance recordings with AQviewer

Open AQviewer by clicking *Disturbance recorder* on AQivate's main toolbar and then select "Launch AQviewer".

You can open disturbance recordings in AQviewer by clicking the "Open" button (the leftmost icon on the main toolbar) or by going to *File* → *Open*. Recordings are packed COMTRADE files. A .zip file includes *.cfg and *.dat. AQviewer can open original packed .zip files and COMTRADE file, as both *.cfg and *.dat are in the same directory.

Adding signals to plotter

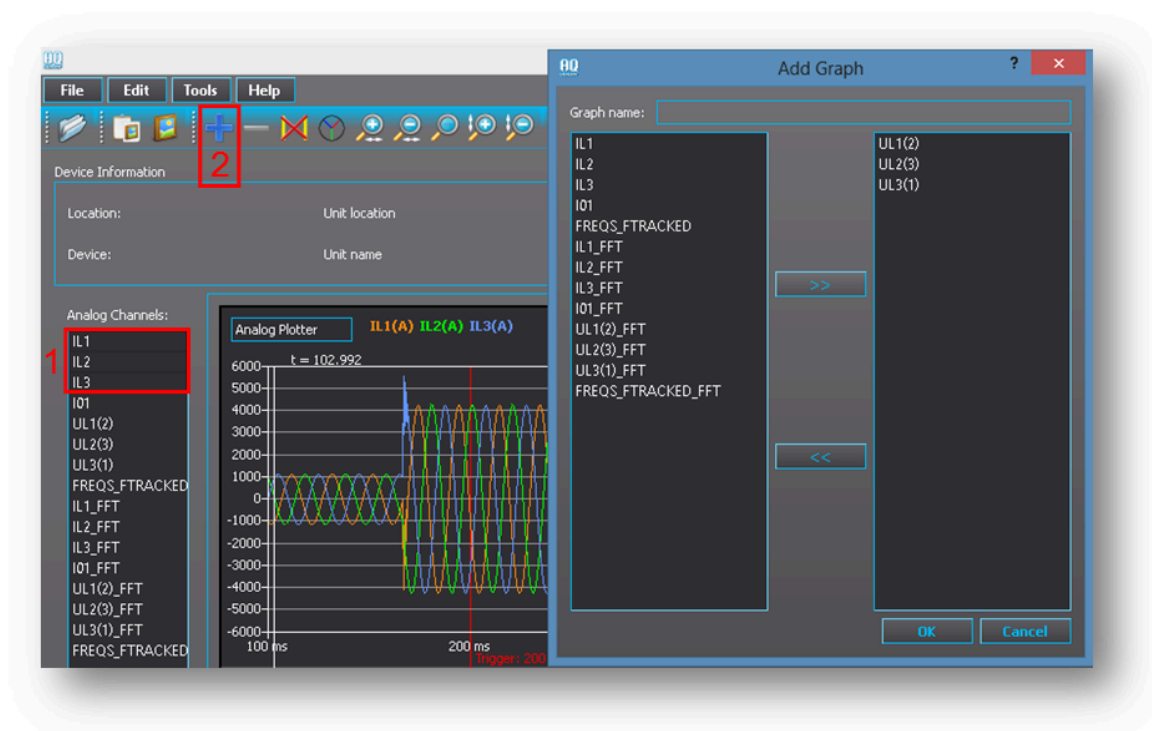

As a default the plotter is empty. You can select the measured signals from the list on the left (see Highlight 1) to move them to the plotter. In this example the phase currents IL1, IL2 and IL2 have been selected.

You can have add another plotter by clicking on the "Add plotter" button (the blue plus sign, see Highlight 2). In this example line-to-neutral voltages UL1, UL2 and UL3 have been selected and moved to the right into the "Add graph" window. Confirm the plotter by pressing the "OK" button.

Other significant AQviewer functions



You can remove a plotter by using the "Remove plotter" button (the red minus sign, see Highlight 1).

You can add cursors to the measure time by double-clicking the left mouse button while on top of any plotter. There can be a maximum of five (5) cursors added simultaneously. You can remove cursors by pressing the "Remove cursors" button (see Highlights 2).

You can zoom in and out by going on top of any plotter, holding down the left mouse button and moving the mouse to create the area you want to zoom in. You can also use the "Zoom" buttons (the magnifying glass icons). You can reset the zooming by pressing the "Zoom reset" (the magnifying glass in the middle). (See Highlights 3.) Note! You can zoom amplitude of individual plotters by holding down **Shift** and scrolling the mouse wheel. You can also zoom time by holding down **Ctrl** and scrolling the mouse wheel.

You can toggle between the primary (P) and the secondary (S) signals (see Highlight 4).

12 Adding an option card

When you want to add a new option card, you must also run a script to the relay to update the relay's hardware configuration and the menu structure. To start this process, contact Arcteq's technical support (<https://support.arcteq.fi/portal/home>) list the following details in the support ticket:

- the relay's serial number ("Serial number")
- the software version ("SW version")
- the hardware configuration in use at the moment ("HW conf.")
- what option card is being added to the relay

You can find all this information in the relay's *General* menu, either from AQtivate or from the relay's HMI (see the image below).

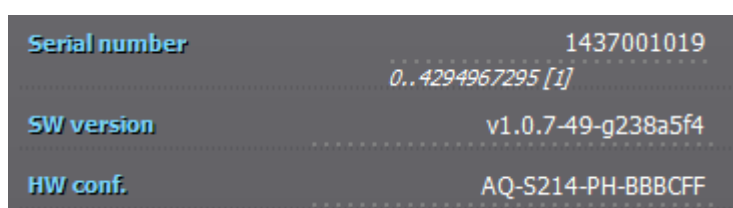

Serial number	1437001019
	0..4294967295 [1]
SW version	v1.0.7-49-g238a5f4
HW conf.	AQ-S214-PH-BBCCFF

Arcteq's technical support will then send you a firmware package that matches the software version as well as a script in a compressed (.zip) folder. The script and the firmware should be placed into a folder with **nothing** else than these files. See the image below for an example of this; note how the firmware package is still compressed while the script is not.

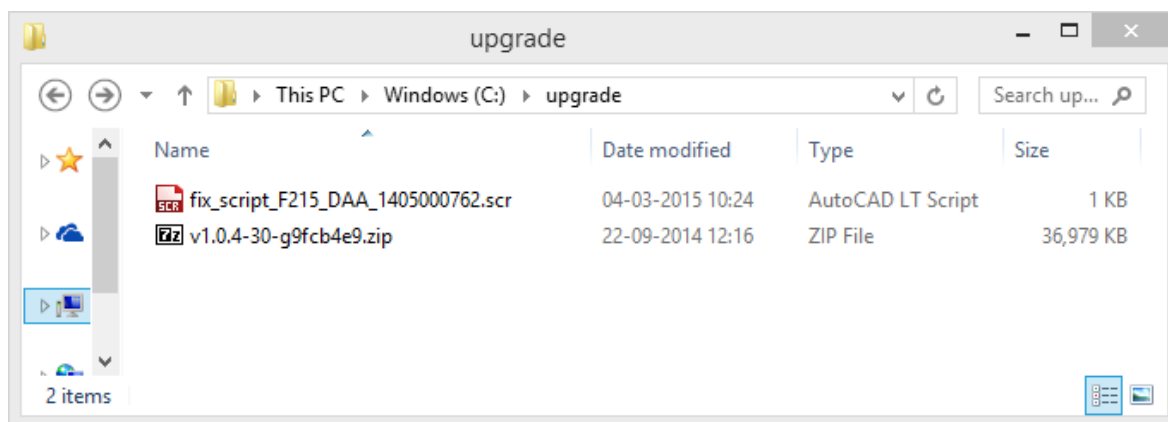

Next, connect to the relay and run the script from *Tools* → *Run script*. When the script has finished running, the relay automatically restarts. If the Error light is on, go to *Monitoring* → *Device diagnostics* → *Clear fault status* → *Clear*. Please note that the Live Edit mode must be activated when you do this in AQtivate.

13 Contact and reference information

Manufacturer

Arcteq Relays Ltd.

Visiting and postal address

Kvartsikatu 2 A 1

65300 Vaasa, Finland

Contacts

Phone:	+358 10 3221 370
Fax:	+358 10 3221 389
Website (general):	arcteq.fi
Website (technical support):	support.arcteq.fi
E-mail (sales):	sales@arcteq.fi